



2024 TOWABLE OWNER'S MANUAL



Hello, I'm Ken Walters, President and CEO of Jayco. I'd like to personally welcome you to the Jayco Family.

The Jayco Family of Companies is comprised of four brands - Jayco, Entegra Coach, Highland Ridge RV and Starcraft RV. These divisions have been manufacturing RVs for over 50 years on a tradition anchored in three pillars – Quality, Team and Family. If you are a first-time owner, thank you for choosing us. If you're a second, third or tenth owner, we are beyond pleased to have kept you in the family.

Our mission has remained unchanged since 1968 – design and build with innovation and safety at the forefront of all we do, and continue to be a leading manufacturer for both towable and motorized RVs. From the first pop-up camper built on the Bontrager family farm, to the technology-packed lineup we build today, we always strive for better.

Over the next few years, we hope the memories made in your new RV are ones to remember. Thank you for taking us along for the ride and for letting us be a part of your stories.

Sincerely,

A handwritten signature in black ink, appearing to read 'Ken Walters', followed by a horizontal line.

Ken Walters
President and CEO of Jayco

Training, How-To and Walk Through Videos

Scan the QR Code to access an extensive video training series for owners of Jayco, Starcraft & Highland Ridge brands of RVs, produced in collaboration with the National RV Training Academy (NRVTA). The series provides an in-depth library of videos to provide new and existing owners with training, reference and how-to material for nearly all of the systems and components you will utilize in your RV.



VIDEO
LIBRARY



Join our Jayco Family Ascend Community - Become a part of something bigger. Ascend is ever-growing and is made up of our Brand Ambassadors, owners in groups and forums and qualified suppliers that we partner with. Our goal is that everyone fits into this community in one way or another. If you own an RV of ours and would like to apply to be a Brand Ambassador, you can learn more here. If you are an owner and you want to meet others within this family, you will find groups and forums we recommend that you join. Our Ascend Community continues to expand year after year, giving all owners connections amongst the masses with people with similar interests. With over 50 brand ambassadors, hundreds of suppliers and thousands of owners, every one of our owners has an ally. Get connected with your tribe.

GET SOCIAL WITH US!



ASCEND
COMMUNITY



SHARE
YOUR STORY



FOLLOW
US



CHANGE OF
OWNERSHIP

ABOUT THIS MANUAL

This manual is a guide to operation of the features, equipment and controls in your recreational vehicle (RV). If you find components vary significantly from what is described, please contact your dealer to ensure you have the correct information. Nothing in this manual creates any warranty, either expressed or implied, nor does it cover every possible detail of equipment, standard or option, installed on or in your RV.

Information, illustrations and specifications in this manual reflect the most current available at the time of publication approval, are subject to change and not intended to indicate actual size.

This Owner's Manual, Warranty Guide, and Customer Information Packet are to be considered permanent components of the RV. Keep them in your RV at all times for personal reference. If the RV is sold, they should remain with the RV for the next owner.

CUSTOMER INFORMATION PACKET

There are components that are excluded from the RV warranty, or are warranted separately by their own individual manufacturer's limited warranty. The Customer Information Packet contains the RV Warranty Guide as well as component manufacturer supplied manuals or information sheets, warranty cards and/or registrations. Consult this information for questions regarding operating, maintenance, servicing instructions and warranty coverage. It is important you complete and mail warranty cards and registrations within the prescribed time limits to avoid loss of warranty coverage.

WINGMATE™ HELP

The Jayco WINGMATE™ icon appears anywhere useful information for a section may be found in the free Jayco WINGMATE™ mobile application.



Jayco WINGMATE is a user-friendly consumer app, designed not only for Jayco owners, but for anyone camping in an RV. The app features quick-start videos, maintenance checklists, how-to tutorials, trip and packing checklists, campsite considerations, Jayco RV Owner's Manuals, and an extensive glossary of RV terms, and more. It is available for free on the Apple App Store and Google Play.

J.JAY HELP

Keep an eye out for J.Jay. He'll be holding a QR code, which when scanned, takes you to info and videos specific to that section.



JAYCO UNIVERSITY

online.rvtechcourse.com/courses/jayco-university

Jayco University, developed by the National RV Training Academy, offers FREE video courses to familiarize you with your RV, how the systems work in your RV, and give you some common troubleshooting advice. You'll see the University logo anywhere there is course content that applies.



SAFETY ALERTS

Throughout this manual, certain items are labeled NOTE, NOTICE, CAUTION, WARNING, and DANGER. These signal words indicate precautions and potential situations, which if not avoided, may result in personal injury, property damage, or damage to your RV. These precautions are listed in the appropriate areas in this Owner's Manual, and in the information contained in the Warranty Packet, and on safety labels affixed to your RV. Read and follow them carefully.

National Safety Associations and organizations require many of the instructions listed. Always use the appropriate safety gear when servicing or maintaining your RV. Please call your dealer or our customer service representatives if you are unsure how to proceed.

NOTE

Gives helpful information.



This is the safety alert symbol. It is used to alert you to potential personal injury hazards. Obey all safety messages that follow this symbol to avoid possible injury or death.



Indicates a potential situation that, if not avoided, may result in property damage or damage to your RV.

WARNINGS AND OTHER LABELS

Informational labels will be attached at various locations on the interior and exterior of your RV. These labels are there for your guidance and protection, and should never be tampered with or removed.



Indicates a potentially hazardous situation that, if not avoided, may result in minor or moderate injury. It may also be used to alert against unsafe practices.



Indicates a potentially hazardous situation that, if not avoided, may result in death or serious injury.



Indicates an imminently hazardous situation that, if not avoided, will result in death or serious injury. This alert information is limited to the most extreme situations.

TABLE OF CONTENTS

SECTION 1: INTRODUCTION

SECTION 2: OCCUPANT SAFETY

SECTION 3: PRE TRAVEL INFORMATION

SECTION 4: VEHICLE OPERATION

SECTION 5: SLIDEOUT SYSTEMS

SECTION 6: ELECTRICAL

SECTION 7: FUEL & PROPANE SYSTEM

SECTION 8: PLUMBING SYSTEM

SECTION 9: HEATING & COOLING

SECTION 10: APPLIANCES

SECTION 11: ELECTRONICS

SECTION 12: INTERIOR

SECTION 13: EXTERIOR

SECTION 14: CHECKLISTS

SECTION 15: ADDITIONAL INFORMATION



TABLE OF CONTENTS

SECTION 1: INTRODUCTION

ASCEND COMMUNITY	3
ABOUT THIS MANUAL	4
CUSTOMER INFORMATION PACKET	4
WINGMATE™ HELP.....	4
J.JAY HELP	4
SAFETY ALERTS.....	4
WARNINGS AND OTHER LABELS	4

SECTION 2: OCCUPANT SAFETY

SECONDARY MEANS OF ESCAPE (EXIT WINDOW)	8
FIRE SAFETY	8
FIRE EXTINGUISHER	8
SMOKE ALARM	8
COMBINATION CARBON MONOXIDE /PROPANE ALARM.....	9
FORMALDEHYDE.....	9
CONDENSATION.....	9
EXTENDED OR FULL TIME USAGE.....	9
COLD WEATHER USAGE	9

SECTION 3: PRE TRAVEL INFORMATION

TOW VEHICLE	11
VEHICLE LABELS.....	11
REAR BUMPER	12
CARGO CARRYING ACCESSORY RECEIVER (IF EQUIPPED).....	12
BIKE RACK (IF EQUIPPED)	12
LOADING YOUR RV	12
TRAVEL TRAILER HITCH (CUSTOMER SUPPLIED)	13
FIFTH WHEEL PIN BOX (CUSTOMER SUPPLIED)	14
WEIGHING YOUR TOW VEHICLE AND RV.....	15
WIRE HARNESS/CONNECTOR PLUG.....	15

SECTION 4: VEHICLE OPERATION

TOWING.....	17
TOWING BEHIND YOUR RV	18
ENTRANCE DOOR STEP(S)	19
STEP LIGHT.....	19
STOWABLE ENTRANCE DOOR STEP.....	19
ENTRANCE DOOR.....	19
LEVELING SYSTEM (IF EQUIPPED)	20
STABILIZERS.....	20
TANDEM AXLE FLEX EQUALIZER (IF EQUIPPED)	21
EMERGENCY STOPPING.....	22
EMERGENCY TOWING.....	22

WHEEL LUGS	22
TIRES.....	23
CHANGING A TIRE	24
SPARE TIRE CARRIER (IF EQUIPPED)	24
TIRE PRESSURE MONITOR SYSTEM (TPMS) (IF EQUIPPED)	24
SETTING UP YOUR RECREATION VEHICLE	25
CAMPSITE HOOK-UP	25
SEASONAL SET-UP (BUNGALOWS ONLY)	26
CARGO RAMP DOOR	28
LOADING THE CARGO AREA.....	29
PATIO DECK - REAR (IF EQUIPPED).....	29
PATIO DECK - SIDE (IF EQUIPPED).....	30
AWNINGS (IF EQUIPPED)	31

SECTION 5: SLIDEOUT SYSTEMS

ELECTRIC SLIDE ROOM(S) (IF EQUIPPED)	36
--	----

SECTION 6: ELECTRICAL

THE ELECTRICAL SYSTEM.....	38
12-VOLT DC SYSTEM	38
LOAD CENTER.....	39
EXTERIOR LIGHTS (IF EQUIPPED)	39
REPLACING LIGHTING.....	39
COMMAND CENTER.....	40
GFCI RECEPTACLE	40
JAYCOMMAND®/TRAVELINK® SYSTEM (IF EQUIPPED)	41
BM PRO MINI SYSTEM (IF EQUIPPED).....	43
JAYVOICE / DIRECTOR (IF EQUIPPED)	44
120-VOLT AC ELECTRIC SYSTEM.....	45
120-VOLT 30-AMP AC ELECTRIC SYSTEM (IF EQUIPPED).....	45
120-VOLT 50 AMP AC ELECTRIC SYSTEM (IF EQUIPPED)	45
TESTING CAMPSITE POWER CONNECTION.....	45
POWERED CORD REEL (IF EQUIPPED).....	46
INVERTER (IF EQUIPPED)	46
CONNECTING POWER CORD(S)	46
POWER CONVERTER	47
120-VOLT CIRCUIT BREAKERS.....	48
APPROXIMATE ELECTRICAL LOAD RATINGS	48
AUXILIARY BATTERY (CUSTOMER SUPPLIED).....	49
DISCONNECT SWITCH (IF EQUIPPED).....	49
GENERATOR (IF EQUIPPED).....	50
SOLAR PREP (IF EQUIPPED)	51
SOLAR PACKAGE (IF EQUIPPED).....	52

TABLE OF CONTENTS

SECTION 7: FUEL & PROPANE SYSTEM

EXHAUST GAS FUMES	55
PROPANE GAS SYSTEM.....	55
PROPANE USE AND SAFETY	57
USING THE FUEL STATION (IF EQUIPPED - SEISMIC ONLY)	58

SECTION 8: PLUMBING SYSTEM

PLUMBING SYSTEM.....	61
MONITOR PANEL	61
FRESH WATER SYSTEM.....	62
FRESH WATER CONNECTIONS	63
WATER PURIFICATION SYSTEM (IF EQUIPPED).....	64
SPRAY PORT (IF EQUIPPED).....	64
TOILET	64
DRAINING THE FRESH WATER SYSTEM	65
UTILITY CENTERS	66
WATER HEATER.....	68
ON DEMAND WATER HEATER (IF EQUIPPED).....	69
FAUCETS	70
BATHROOM TUB / SHOWER.....	70
OUTSIDE SHOWER (IF EQUIPPED)	70
BLACK/GREY WATER SYSTEM AND TANKS	71
BLACK AND GREY TANK DRAINS	72
MACERATOR PUMP SYSTEM (IF EQUIPPED).....	73
BLACK TANK FLUSH (IF EQUIPPED).....	74
TANK HEATERS (IF EQUIPPED)	74
SANITIZING/WINTERIZING THE PLUMBING SYSTEM.....	75

SECTION 9: HEATING & COOLING

AIR CONDITIONER	80
POWER ROOF VENT (IF EQUIPPED).....	80
FIREPLACE (IF EQUIPPED)	80
CEILING FAN (IF EQUIPPED).....	81
FURNACE	81

SECTION 10: APPLIANCES

MICROWAVE	82
COOKTOPS, RANGE AND OVEN (IF EQUIPPED).....	82
RANGE HOOD (IF EQUIPPED).....	83
COOKING SAFETY.....	83
REFRIGERATOR	83
JAYPORT™ AND GAS BBQ GRILL	84
PROPANE GRILL QUICK COUPLER	84
OUTSIDE KITCHEN (IF EQUIPPED).....	84

TAILGATER CAMP KITCHEN (IF EQUIPPED - SEISMIC).....	85
WASHER/DRYER PREP (IF EQUIPPED)	86
CENTRAL VACUUM SYSTEM (IF EQUIPPED).....	86

SECTION 11: ELECTRONICS

WINEGARD® AIR™ 360 ANTENNA.....	89
WINEGARD® GATEWAY ROUTER (IF EQUIPPED).....	89
CAMERA PREP/CAMERA (IF EQUIPPED)	90
EXTERIOR SLIDING / PIVOTING TV (IF EQUIPPED).....	90

SECTION 12: INTERIOR

CLEANING THE INTERIOR.....	91
SOFAS AND DINETTES	91
TOKYO BED (IF EQUIPPED)	93
POWER BUNK BED (SEISMIC CARGO BAY)	93
MURPHY BED (IF EQUIPPED)	95
STANDARD BED STORAGE	95
BUNK BED AND LOFT LADDERS (IF EQUIPPED).....	96
BED RAILS.....	96

SECTION 13: EXTERIOR

CLEANING THE EXTERIOR.....	98
CLEANING SLIDE-OUT SEALS	99
E-Z LUBE® OR SUPER LUBE™ AXLE (IF EQUIPPED)	100
EXTERIOR ROOF AND SIDEWALL VENTS	100
WINDOWS	100
EXTERIOR LADDER (IF EQUIPPED)	100
SEALANTS.....	101

SECTION 14: CHECKLISTS

TRAVEL CHECKLIST.....	103
RV STORAGE CHECKLIST	104

SECTION 15: ADDITIONAL INFORMATION

FEATURED COMPONENTS QUICK REFERENCE CHART	105
HELPFUL LINKS	106



SECTION 2: OCCUPANT SAFETY



SECONDARY MEANS OF ESCAPE (EXIT WINDOW)

CAUTION (See Page 10)

Your RV has been equipped with a window(s) that serves as a secondary means of escape. The window(s) will allow a quick exit from the RV during an emergency if access to the main entrance door is not available. It is easily identified by the red latches and label.

Do not remove the EXIT window label(s).

When parking your RV, make sure the egress window is not blocked by trees or other obstacles. Make sure the ground below the window is solid and can be used as an escape path.

Practice opening the window before an emergency occurs, and make sure all occupants know how to operate it.



Exit Window Label

NOTE

All windows must be closed and locked while the RV is in transit.

Your RV may be equipped with one of the following exit window styles:

Flip latch style (2 per window)

1. Push up on the front lip of the latch and the latch unfolds.
2. Push up on the front lip of the latch again to unhook the latch from the window.
3. When both latches are released, push out on the window, which is hinged at the top. Exit the RV.



The screen does not need to be removed from the window.

Slider window latch style

1. Pull the lever down to unlock the window.
2. Slide the window to the right to open.
3. Exit the RV.



The screen does not need to be removed from the window.

Lever style latch

1. Remove the screen by pulling the red tab (upper right arrow).
2. Pull the lever out from the sash clamps.
3. Swing the lever out so it is positioned straight out from the window.
4. Push the lever (and window) out to open.
5. Exit the RV.



FIRE SAFETY

DANGER (See Page 10)

If a fire does start, follow these basic safety rules:

1. Evacuate everyone from the RV immediately and call 911.
2. Make sure everyone is accounted for.
3. Get clear of the RV and allow the fire department to handle the emergency.

FIRE EXTINGUISHER

WARNING DANGER (See Page 8)

A dry chemical fire extinguisher has been installed by the entrance door. It is suitable for extinguishing small fires of the Class B or C type (flammable liquids and electrical) only.

We suggest you become thoroughly familiar with the operating instructions displayed on the side of the fire extinguisher.

For information on fire extinguisher use, refer to the fire extinguisher user's manual included in your customer information packet.

SMOKE ALARM

WARNING (See Page 10)

A smoke alarm is installed in every RV for your safety. Most detectors are powered by a 9 volt battery that should be inspected and replaced as needed. Keep the smoke alarm free of dust. Refer to and follow in detail the safety, testing, troubleshooting, maintenance, and smoke alarm expiration and replacement information found in the manufacturer's user guide located in your customer information packet.

COMBINATION CARBON MONOXIDE /PROPANE ALARM

⚠ DANGER ⚠ **⚠ WARNING ⚠** (See Page 10)

Your RV is equipped with a combination carbon monoxide (CO) / propane alarm that is listed for use in RVs. The alarm is directly wired to the 12-volt electrical system, with continuous power being supplied by the RV batteries. **If the battery cable is disconnected at the battery terminals, the combination alarm will not work.**



Carbon monoxide/ Propane alarm (alarm may vary)

Be sure to read, understand and follow the owner's information from the manufacturer of the combination CO/propane alarm. This includes information regarding the limited life of the alarm.

Carbon monoxide (CO) is an insidious poison. It is a colorless, odorless and tasteless gas. Many cases of reported carbon monoxide poisoning indicate while victims are aware they are not well, they become so disoriented they are unable to save themselves by either exiting the RV or calling for assistance. Young children and household pets may be the first affected.

The following symptoms are related to carbon monoxide poisoning and should be discussed with all members of the household:

- Mild exposure: Slight headache, nausea, vomiting, fatigue (often described as "flu-like" symptoms).
- Medium exposure: Severe throbbing headaches, drowsiness, confusion, fast heart rate
- Extreme exposure: Unconsciousness, convulsions, cardio-respiratory failure, death

Your combination carbon monoxide/propane alarm is designed to detect the toxic carbon monoxide fumes that result from incomplete combustion, such as those emitted from appliances, furnaces, fireplaces and auto exhaust.

Maintenance

Vacuum the alarm cover at least once a year. Clean the cover by hand using a cloth dampened in clean water. Dry with a soft cloth. Do not spray the front panel of the alarm with cleaning agents or waxes. This action may damage the sensor causing an alarm or cause the alarm to malfunction. Do not paint the face of the alarm.

Refer to the carbon monoxide/propane alarm manufacturers user's manual provided with your RV for additional information on functions and alarm testing.

Test the alarm operation after the RV has been in storage, before each trip and at least once per week during use.

Repair or replace the combination carbon monoxide/propane alarm when the alarm no longer functions.

The carbon monoxide/propane alarm manufacturer strongly recommends replacement of the detector five years after the date of purchase.

FORMALDEHYDE

Some components in the RV contain formaldehyde-based adhesives that may release formaldehyde fumes into the air for an unknown period of time. Individuals who are allergic to formaldehyde gas fumes may experience irritation to eyes, ears, nose and throat. Indoor air quality may also be affected by leaving your RV closed for a period of time.

To aid in dissipation, ventilate the RV by opening all windows and circulate the air with a fan.

CONDENSATION

⚠ WARNING ⚠ (See Page 10)

Condensation is a natural phenomenon. The amount of condensation will vary with climate conditions, particularly the relative humidity. Condensation occurs because there is water vapor present in the air. When the temperature reaches the "dew point" the water vapor in the air condenses and changes to a liquid form.

Proper ventilation or the use of a dehumidifier (customer supplied) will assist in controlling the condensation. Suggestions to eliminate warm moist air:

- Crack open windows and roof vents to allow warm moist air to escape.
- Open the bath roof vent (if equipped) approximately 1/2" when showering.
- Use the range hood fan (if equipped) when cooking or washing dishes.
- Avoid hanging wet towels (or clothes) inside the RV to dry.
- If found in cabinets or closets, open the doors slightly to provide ventilation.

EXTENDED OR FULL TIME USAGE

⚠ CAUTION ⚠ (See Page 10)

Unless specifically marked for full time use, your RV is not intended for use as full-time quarters or a permanent residence. Continuous living in your RV could cause accelerated wear and damage to the various components.

COLD WEATHER USAGE

When used in freezing or below freezing temperatures, the precautions should be taken:

- Fresh water and drainage systems - preparations to avoid freeze-ups.
- Propane gas (if equipped) and sufficient power is needed for protection from possible freeze-ups on the propane gas regulator. Keep in mind that more frequent furnace operation will substantially increase battery draw and propane gas use.
- During cool weather usage, ventilation or addition of a dehumidifier may be required to reduce condensation.
- Check outside extrusions on compartment doors, locks, slide outs, windows, vents, etc., for frozen moisture before operating to avoid damage to parts.

DANGER

OCCUPANT SAFETY DANGER

FIRE SAFETY (Page 8)

Do not attempt to use water to put out the fire. Water can spread some types of fire, and electrocution is possible with an electrical fire.

FIRE EXTINGUISHER (Page 8)

Do not turn the electrical power back on or plug in any appliances after the use of a fire extinguisher. Please refer to the fire extinguisher's user manual for further instructions on maintenance and clean up.

CARBON MONOXIDE /PROPANE ALARM (Page 9)

If alarm is triggered, exit the vehicle immediately and call for assistance. The gases may dissipate before help arrives, but it is imperative that the source of the leak is found and repaired.

Your combination carbon monoxide/propane alarm is designed to detect the toxic carbon monoxide fumes that result from incomplete combustion, such as those emitted from appliances, furnaces, fireplaces and auto exhaust as well as propane leaks. Consult the user's guide for instructions and audible/visual warning details.

WARNING

OCCUPANT SAFETY WARNING

FIRE EXTINGUISHER (Page 8)

Do not check the pressure, test or practice using the fire extinguisher by squeezing the trigger, even briefly. The fire extinguisher is not rechargeable or refillable. Once used, it will gradually lose pressure and will not be fully charged for use in an emergency.

SMOKE ALARM (Page 8)

This smoke alarm will not alert hearing impaired residents. Special alarms with flashing strobe lights are recommended for the hearing impaired.

Only use the replacement battery recommended by the smoke detector manufacturer. The smoke detector alarm may not operate properly with other batteries. Never use a rechargeable battery as it may not provide a constant charge. Never disconnect the battery to silence the alarm.

Test the smoke alarm operation after the vehicle has been in storage, before each trip and at least once per week during use. Do not disconnect the battery or the alarm.

CONDENSATION (Page 9)

Condensation may cause dampness, mildew, mold, staining and, if allowed to continue, it may result in damage to the recreation vehicle (damage caused by condensation is not warrantable). It can also lead to mold or mildew issues, which could be a health hazard.

CARBON MONOXIDE /PROPANE ALARM (Page 9)

Do not cover or obstruct the carbon monoxide/propane alarm with anything that could prevent gas from entering the alarm.

Actuation of this detector indicates the presence of carbon monoxide which can kill you. This alarm is not designed to detect smoke, fire or gases other than carbon monoxide and propane.

The carbon monoxide detector installed is intended for use in ordinary indoor locations of recreation vehicles. It is not designed to comply with Occupational Safety and Health Administration (OSHA) commercial or industrial standards.

Individuals with medical problems may consider using warning devices that provide audible and visual signals for carbon monoxide concentrations under 30 PPM.

This alarm will only indicate the presence of carbon monoxide gas at the sensor. Carbon monoxide gas may be present in other areas.

The ultimate responsibility for protection against toxic carbon monoxide fumes rests solely on you. Installing a carbon monoxide/propane alarm is just the first step in protecting your family from toxic carbon monoxide poisoning.

Do not disconnect the battery or the alarm.

Never turn the 12-volt battery disconnect control to the off position and disconnect the battery cable to silence an alarm. The alarm will automatically sense when the level of carbon monoxide in the air reaches below dangerous levels. You should stay outside the vehicle in fresh air until the alarm is silenced. When the alarm sounds, do not stand too close to the alarm. The sound produced by the alarm is loud (85db) because it is designed to wake a person in an emergency. Prolonged exposure to the alarm at a close distance may be harmful to your hearing.

CAUTION

OCCUPANT SAFETY CAUTION

SECONDARY MEANS OF ESCAPE - EXIT WINDOW (Page 8)

Exercise care when opening the exit window. If opened too far, it may come off the hinge. This may result in damage to the unit or window.

EXTENDED OR FULL TIME USAGE (Page 9)

Continuous or permanent living in your recreation vehicle may affect your warranty coverage and may void the "Limited Warranty" applicable to your vehicle.

SECTION 3: PRE TRAVEL INFORMATION



TOW VEHICLE

If you plan to tow your RV with a tow vehicle you already own, or if you plan to purchase a new one, make sure the Gross Vehicle Weight Rating (GVWR) of your RV does not exceed your tow vehicle's towing rating. Ask your automotive dealer how to obtain a copy of information that deals with towing considerations, with or without an optional vehicle tow package.

VEHICLE LABELS

⚠ WARNING ⚠ (See page 16)

Decals and data plates used throughout the RV aid in its safe and efficient operation; others give service instructions. Read all decals, data and instruction plates before operating your RV. Any decal, data or instruction plate painted over, damaged or removed should be replaced.

Keep a record of the 17-digit chassis vehicle identification number (VIN), the 8-digit serial number, and your license number in the event theft or vandalism requires you to supply this information to the authorities.

WEIGHT TERMS

GAWR - Gross Axle Weight Rating: The value specified by the vehicle manufacturer as the load-carrying capacity of a single axle system, as measured at the tire-to-ground interfaces. This is the total weight a given axle system is capable of carrying.



GCWR - Gross Combined Weight Rating: The value specified by the trailer manufacturer as the maximum allowable loaded weight of the trailer including full propane cylinders, a full load of water, and full generator fuel if applicable.

GVWR - Gross Vehicle Weight Rating: The value specified by the manufacturer as the maximum permissible weight of the fully loaded trailer.

OCCE - Occupant And Cargo Carrying Capacity: Is equal to the GVWR of the trailer, minus the:

- Weight of the trailer (as completed at the factory).
- Weight of all personal cargo.
- Weight of a full tank (or tanks) of propane (if applicable).

- Full weight of potable water, including the water heater.

Additions to or other changes made to the trailer after it left the factory will affect (reduce) the OCCE.

UVW - Unloaded Vehicle Weight: The weight of the trailer as manufactured at the factory with the weight of a full tank (or tanks) of propane.

WEIGHT AND CAPACITY LABELS

The following labels are typically located on the roadside front corner of the RV. An additional Cargo Carrying Capacity label may also be located on or near the entry door.

CCC Label (Cargo Carrying Capacity):

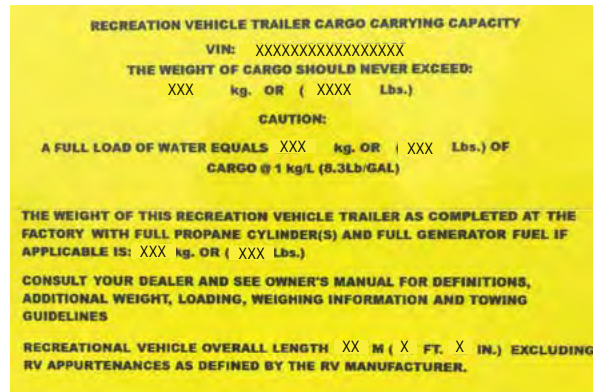

CCC Label Example

The upper portion of this yellow label is federally required and includes the maximum Cargo Carrying Capacity that may be placed in or on the trailer as it was manufactured and weighed before leaving the factory. This maximum capacity would not include the weight of a full fresh water tank.

NOTE

Labels for the Canadian market are white and weight measurements include the weight of a full water heater and fresh water tank.

Additions or other changes made to the trailer after it leaves the factory will affect (reduce) the CCC.

The middle portion of this label is provided voluntarily and indicates the weight value of the trailer as it was manufactured and weighed

PRE TRAVEL INFORMATION

at the factory. It includes full propane tanks and full generator fuel (if equipped).

For example, if the tires are rated at 2,000 lbs. each x 4 tires = 8,000 lbs. and the RV has a GVWR of 9,000 lbs. with a tongue weight of 1,200 lbs. The actual weight on the RV tires is (9,000 – 1,200) which equals 7,800 lbs. which is within the weight rating of the tires.



NOTE

The total weight capacity of the tires on your RV can be less than the GVWR. The calculation for the actual weight on the RV tires does not include the tongue weight. Your tow vehicle, not the RV tires, is actually carrying the tongue weight.

The Federal Certification Label

MFG. BY:	RV MANUFACTURER NAME	Date:	XX/XX
VIN: XXXXXXXXXXXXXXXXXX			
GVWR KG/LBS. 3719 / 8200	SIZE/DIMENSION		
GAWR KG/LBS.	TIRE	RIMS	COLD INFL. PR. / PSI
XX / XX	FRONT XXXXX/XXXXXX	XXXX X	XX / XX
XX / XX	REAR XXXXX/XXXXXX	XXXX X	XX / XX
TYPE OF VEHICLE: TRAILER			
THIS VEHICLE CONFORMS TO ALL APPLICABLE U.S. FEDERAL MOTOR VEHICLE SAFETY STANDARDS IN EFFECT ON THE DATE OF MANUFACTURE SHOWN ABOVE.			

Federal Certification Label Example

The Federal Certification Label is required by the government to verify the trailer complies with all motor vehicle standards for Canada and the United States. It includes the following information: Manufacturer name, VIN, GVWR, GAWR (front/rear), tire and rim sizes and cold tire inflation pressures.

Tire and Loading Label

TIRE AND LOADING INFORMATION RENSEIGNEMENTS SUR LES PNEUS ET LE CHARGEMENT			
The weight of cargo should not exceed XXX kg or XXXX lbs. Le poids du chargement ne doit jamais dépasser XXX kg ou XXXX lbs.			
TIRE PNEU	SIZE DIMENSIONS	COLD TIRE PRESSURE PRESSION DES PNEUS A FROID	SEE OWNER'S MANUAL FOR ADDITIONAL INFORMATION
FRONT AVANT	XXXXX/XXXXXX	XXX KPA, XX PSI	VOIR LE MANUEL DE L'USAGER POUR PLUS DE RENSEIGNEMENTS
REAR ARRIERE	XXXXX/XXXXXX	XXX KPA, XX PSI	
SPARE DE SECOURS	XXXXX/XXXXXX	XXX KPA, XX PSI	

Tire and Loading Label Example

Tire and Loading Label provides information on the tire sizes, cold tire inflation pressures, the VIN and maximum cargo capacity. The maximum cargo capacity listed on the label does not include the weight of a full load of water.

If you have further questions, please contact your dealer or our Customer Service department.

LOADING YOUR RV

⚠ WARNING ⚠ (See page 16)

Store and secure all loose items inside the RV before traveling. Distribute cargo side-to-side so the weight on each tire does not exceed one-half of the GAWR for either axle. Make sure any tie down straps (if equipped) on appliances or furniture are secure. Load heavy objects on the floor, or as low as possible.

REAR BUMPER

⚠ CAUTION ⚠ (See page 16)

The rear bumper of your RV is not designed to carry cargo. Items that extend beyond the bumper or weigh over 100 lbs. (45kg) will place undo strain on the bumper. The 100 lb. bumper capacity includes the weight of the spare tire (if equipped).

NOTE

Some items may fall within the given weight range, (IE: bike racks) however, they can still cause damage. In addition, extra weight behind the axle may reduce the hitch weight which can adversely affect handling.

CARGO CARRYING ACCESSORY RECEIVER (IF EQUIPPED)



Receiver is for cargo carrying accessories ONLY. DO NOT tow any trailer or other vehicle. Load Limit for this receiver is 300 lbs. maximum. Use for towing or exceeding load limit will void the warranty. Failure to follow the instructions can cause the carrier to collapse or items to fall which could cause an accident resulting in death or serious injury.

BIKE RACK (IF EQUIPPED)

⚠ WARNING ⚠ **⚠ CAUTION ⚠** (See page 16)

Your RV may be equipped with a bike rack. Refer to the bike rack manufacturer's owner's manual for detailed safety and user information.



TRAVEL TRAILER HITCH (CUSTOMER SUPPLIED)

CAUTION (See page 16)

Hitch selection affects the towing and handling characteristics of your RV. There are many kinds of hitches available and assuring that you have the correct hitch installed is critical to safe towing.

Ask your dealer about the proper class and type of hitch you need for your individual tow vehicle/RV combination. A travel trailer requires a frame mounted hitch.

The hitch class rating is based on the capacity that hitch has for towing and a weight classification. The weight classification is determined from the hitch's weight carrying capacity (the tongue weight on a travel trailer). Before selecting a hitch, you must know your GVWR and tongue weight. **The rating of the hitch package purchased should be equal to or greater than the RV's GVWR and the hitch weight.**

Equipment that sometimes gives autos, trucks and sport utility vehicles a softer ride can accentuate swaying when pulling an RV. Suspension that is too stiff will increase vibration, bounce and accelerate wear of your tow vehicle and RV combination.

Your RV manufacturer cannot be responsible for the suspension system of any tow vehicle. There are a variety of tow vehicle suspension systems available that will affect the ball height, stability and levelness of a hooked up RV. Make sure your dealer is aware of the tow vehicle you are using so a compatible hookup is achieved.

Travel trailer hitch weight

Maintain the proper tongue weight of the trailer. Stay within the target range of 10%-15% of the overall gross weight (travel trailer weight plus contents).

Travel trailer hitch height and hitch ball

To determine the hitch height for your model, make sure that the trailer is level. When the loaded RV is hitched to the tow vehicle, check the hitch ball height. This can be determined by measuring the distance from the center of the hitch ball to the ground. Record this number in the box for future reference.

Hitch height is:

Adjust the hitch assembly so that the tow vehicle and the trailer are essentially level. A high hitch will transfer weight behind the axles and cause the vehicle to fishtail. A low hitch will transfer additional weight to the hitch. Refer to the hitch manufacturer instructions to adjust the weight-distributing hitch to the proper height.

If you have additional questions, consult with your dealer. Make certain your dealer is aware of the tow vehicle you are using so a compatible hookup is achieved. Depending on the model, your required travel trailer hitch ball diameter is either 2" or 2-5/16" (consult your dealer for assistance).

Travel Trailer Hitching Procedure

The following procedure will help to assist you in securely hooking up your RV to your tow vehicle.

1. Chock the trailer wheels.

2. Turn the tongue jack crank (or press EXTEND/UP on electric jacks) to raise the travel trailer tongue above the hitch ball.
3. Open the coupler latch on the travel trailer hitch.
4. Back the tow vehicle into the proper position.
5. Turn the tongue jack crank (or press RETRACT/DOWN on electric jacks) to lower the coupler onto the hitch ball.
6. Close the coupler latch after it is completely seated.
7. Install the (customer supplied) weight distributing bars (equalizers) as directed by the OEM (if equipped).
8. Remove any dolly wheel or platform and retract the tongue jack to its maximum height off of the ground.
9. Attach the breakaway switch cable to the tow vehicle.
10. Attach the safety chains (See "Travel Trailer Safety Chains" on page 14).
11. Plug in your wire harness/connector plug from the tow vehicle to the travel trailer.
12. Walk around the RV to verify exterior lights are working correctly.
13. Remove the trailer wheel chocks.

NOTE

If using a brake actuator, refer to the manufacturer's owner's manual for detailed and important hitching and safety information.

Travel Trailer Weight Distributing System (customer supplied)

This system provides a more stable tow vehicle/RV combination. It will distribute the weight evenly to the tow vehicle front and rear axles and the trailer axle. Consult with your dealer for information on requirements and operation of this system. Be certain your tow vehicle can carry the hitch weight.

Travel Trailer Sway Control (customer supplied)

Sway control devices are available to reduce the sway produced by crosswinds, air displacement caused by other vehicles passing you in transit, incorrect weight distribution, excessive speed, the RV tires dropping onto the shoulder of the road, etc. Have a sway control device installed to help control side-to-side movement and keep sway in check. Consult your dealer for additional information.

Suggestions for sway situations:

- Slowly ease your foot off the accelerator.
- Turn the steering wheel as little as possible. Natural lag time reaction when counter-steering to correct sway could possibly make it worse.
- As soon as possible, stop to determine the cause of the sway. Check all equipment and load distribution. If the problem cannot be solved immediately, contact your dealer for a service appointment. Reduce your speed until the issue is resolved.



Sway Control/ Weight Distribution Hitch Example



PRE TRAVEL INFORMATION

Travel Trailer Safety Chains

Your RV is equipped with chains to meet SAE standard requirements for maximum gross trailer weight. Always have the safety chains attached when towing. Install them as shown below so they do not restrict sharp turns, but tight enough so they do not drag on the ground.

Crisscross the left safety chain under the coupler and attach to the right mounting slot in the trailer hitch; repeat with the right safety chain. Slack for each length should be the same but not more than necessary to permit the vehicle to turn at its minimum radius, but tight enough not to drag on the ground.

NOTE

Your RV's emergency brake line should never be installed to the safety chain or safety chain hook. Attach the emergency brake line to a permanent fixture on the tow vehicle with a sturdy carabiner or other strong removable connector.

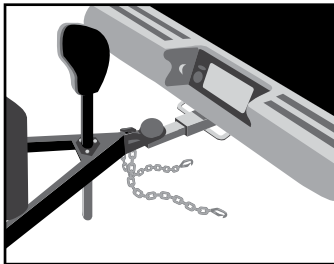

1. Inspect chains to determine if they are properly attached to the trailer frame.

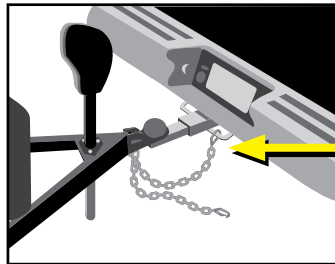

2. Connect driver side chain to passenger side mounting point on tow vehicle hitch.

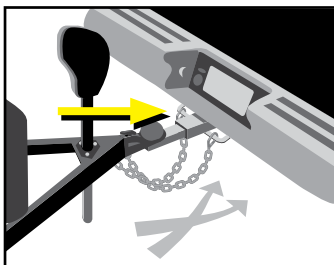

3. Connect passenger side chain to driver side mounting point on tow vehicle hitch. Chains should cross but not touch the ground.

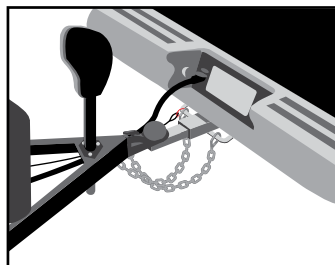

4. Properly mounted safety chains. Trailer plug and emergency brake line attached. Trailer jack raised.

FIFTH WHEEL PIN BOX (CUSTOMER SUPPLIED)

CAUTION (See page 16)

Hitch selection affects the towing and handling characteristics of your RV, and is critical to safe towing. Talk to your dealer about the appropriate hitch for your individual tow vehicle/RV combination. A fifth wheel requires a pin box hitch bolted directly to the floor of the truck bed through the frame.

Your tow vehicle's bed length will also determine hitch options. Using the wrong hitch on a short bed truck, as an example, could cause damage to the truck when the front edge of the trailer swings into the truck cab during tight turns while backing up.

The rating of the hitch package purchased should be equal to or greater than the RV's GVWR and the pin box rating.

Suspension equipment that gives trucks and sport utility vehicles a softer ride can often accentuate swaying when pulling an RV. Conversely, suspension that is too stiff will increase vibration, bounce, and accelerate wear of your tow vehicle and RV combination. **Your RV manufacturer cannot be responsible for the suspension system of any tow vehicle. There are a variety of tow vehicle suspension systems available that will affect the pin box height, stability and levelness of a hooked up RV.**

The fifth wheel factory installed pin box is not interchangeable. Maintain the proper pin box weight on the hitch. A low hitch will transfer additional weight to the hitch. Refer to a professional to adjust the hitch to the proper height.

If you have additional questions, consult with your dealer. Make certain your dealer is aware of the tow vehicle you are using so a compatible hookup is achieved.

Fifth Wheel Hitching Procedure

WARNING (See page 16)

The following procedure will help to assist you in securely hooking up your RV to your tow vehicle.

1. Chock the trailer wheels.
2. Make sure the hitch lever is in its open or "cocked" position unless it has been designed to open automatically.
3. Adjust the fifth-wheel travel trailer pin to the proper height by raising or lowering the landing gear.
4. Lower the tailgate, if applicable.
5. Back the truck so the hitch encircles the fifth-wheel/travel trailer pin. You may need to adjust the trailer pin height to be even with or slightly below the coupler.
6. A gentle contact of the hitch saddle jaws against the pin will cause the mechanism to close.
7. Secure the hitch lever as specified by the manufacturer.
8. Put the truck in drive (DO NOT press on the accelerator) and 'bump' the hitch to make sure it is locked. After which, put the truck back in park.
9. Be sure to raise the fifth-wheel landing gear all the way up.
10. Attach the breakaway switch cable to the tow vehicle.
11. Plug the wire harness/connector plug from the tow vehicle to the fifth wheel.
12. Remove the wheel chocks from the trailer wheels.



Fifth wheel landing gear can be operated manually. The fifth wheel landing gear must be fully retracted before moving or towing the RV to prevent damage.

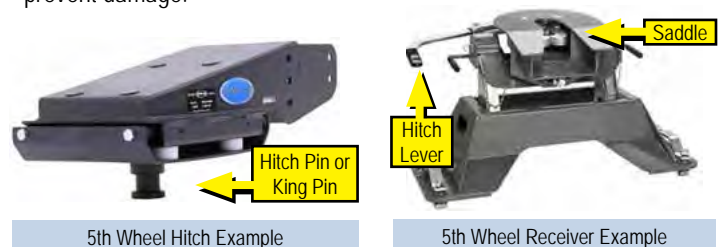

WEIGHING YOUR TOW VEHICLE AND RV

When the RV is fully loaded it should be weighed. The actual weight of the RV, all options, liquids, the hitch weight, and your personal cargo is important for you to know so you do not exceed the GVWR. Two important factors when loading your RV are total weight and balance.

It is imperative that you verify compliance within all applicable weight ratings. Overloading your RV will void the **Towable Limited Warranty** and the warranties of many component part manufacturers.

Periodically weigh your RV at a public scale to determine proper load distribution. To obtain the side-to-side weights, there needs to be enough space on either side of the scale to accommodate the RV being partially off the scale. **Keep in mind that individual scales will operate differently.**

To weigh your tow vehicle and RV

⚠ WARNING ⚠ (See page 16)

Your RV must be weighed loaded as you would drive with it with food, clothing, fuel, water (if dry camping), propane, supplies, etc.

1. Weigh the RV, including the tongue weight, while detached from the tow vehicle. This actual overall weight must be less than or equal to the GVWR for safe operation. If the overall weight is greater than the GVWR, some contents must be removed until the actual overall weight is less than or equal to GVWR.
2. Hitch the RV to your tow vehicle. Weigh the RV and the tow vehicle to determine the GCW. Make sure that this rating is less than or equal to the GCWR as specified by the manufacturer of your tow vehicle. If this overall weight is greater than the GCWR, some contents must be removed to bring the combination into compliance with the listed ratings.
3. Weigh the RV while attached to but excluding the tow vehicle. This will result in the actual weight that is exerted on all of the RV tires. This weight may be subtracted from the overall RV GVWR to determine the actual "tongue" weight.
4. With the RV still attached to the tow vehicle, weigh each wheel position separately to ensure each tire is not overloaded.

To determine the wheel position weight

1. Pull the RV onto the scale so only one side's tire(s) is on the scale. Record the weight. Your RV must remain as level as possible (even though one side is not physically on the scale).
2. To calculate the opposite side RV wheel position weight, subtract the first side's weight from the weight determined in step #3.

If there is a difference in the weights on one side of the RV as compared to weights on the other side, rearrange cargo to try to equalize the load and not overburden the suspension on one side.

Once actual weights are obtained, compare them to the **Weight Information Label** weight ratings to ensure you are below the posted minimum ratings.

See *"WEIGHT TERMS"* on page 11 and *"LOADING YOUR RV"* on page 12 for important weight information.

WIRE HARNESS/CONNECTOR PLUG

A 7-way wire harness/connector plug is wired into your trailer to connect electrical power from the tow vehicle for travel. This supplies power to the RV brakes, taillights, clearance lights, turn signals, brake lights, etc. Wiring to operate your brakes must be the same size in both the tow vehicle and RV (the RV brake wiring is 12-gauge wire).

The connector plug may build up corrosion with extended use. It should be cleaned periodically to insure good electrical contact. Make sure the connector plug is kept clean and protected from road elements as you travel.

NOTE

A 12V circuit tester is recommended to verify the trailer connections.

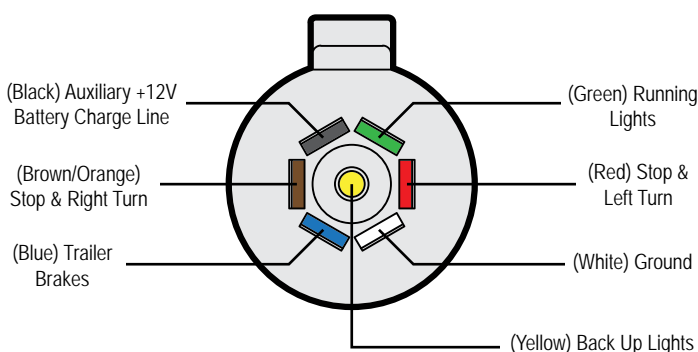

7-Way Trailer Plug (Cord End)



WARNING

PRE TRAVEL INFORMATION WARNING

VEHICLE LABELS (page 11)

The factory-installed weight labels are specific to the recreation vehicle for which they are supplied and are not interchangeable. Do not remove these labels from your vehicle. If labels are missing contact your dealer or Customer Service for replacements.

Do not exceed any applicable weight ratings. Doing so could damage your RV or tow vehicle and adversely affect handling and braking characteristics.

LOADING YOUR RECREATION VEHICLE (page 12)

Never load the RV in excess of the GAWR for either axle. Overloading your RV may result in adverse handling characteristics and damage to the RV.

DO NOT EXCEED YOUR GVWR! This means you should weigh your RV as loaded for your normal travel to determine the actual weight. If you exceed the GVWR, you **MUST** remove items from the RV, or drain liquids, then re-weigh the vehicle to ensure you have achieved a safe weight. Do not travel with full grey/black holding tanks. This not only wastes gas but, depending upon the location of the grey or black holding tanks, can affect handling characteristics

Your recreation vehicle's load capacity is designated by weight, not by volume, so you cannot necessarily use all available space when loading the vehicle. Do not exceed your GVWR and ensure you are loading the vehicle as evenly as you can for the best possible handling. Ensure heavy items are secured so they do not shift during travel.

Store items in areas designated for storage. Do not store anything in the areas reserved for the converter, electrical panels or the furnace or water heater, etc.

BIKE RACK (page 12)

It is critical that you properly secure the bikes to the bike rack. You are responsible for securing bikes to your bike rack, checking the attachments prior to use, and periodically inspecting the products for adjustment, wear, and damage. You should read and understand all of the information supplied with your product prior to use. The bike rack should only be used for transporting bikes. Failure to properly attach and secure bikes to the rack, or using the racks to transport items other than bikes, may result in property damage or serious injury.

FIFTH WHEEL HITCHING PROCEDURE (page 14)

DO NOT USE THE FIFTH WHEEL LANDING GEAR TO SUPPORT THE TOW VEHICLE WEIGHT. The fifth wheel landing gear is designed to bear the front loaded weight of the RV only.

WEIGHING YOUR TOW VEHICLE AND RV (page 15)

Total weight of your tow vehicle and RV must not exceed the GCWR. Do not assume that you can tow a RV that happens to be within the capacity of the tow vehicle hitch. By doing so, you may exceed the total GCWR of your tow vehicle and RV towing combination.

It is important to redistribute the load to avoid component failure as well as to improve the handling characteristics of the vehicle and not void the Towable Limited Warranty.

CAUTION

PRE TRAVEL INFORMATION CAUTION

REAR BUMPER (page 12)

Do not add items to the recreation vehicle rear bumper. Add-on items will eventually damage your bumper. Damage caused by such aftermarket equipment installation or improper loading voids the Towable Limited Warranty.

BIKE RACK (page 12)

Always make sure all connections between the bicycle rack and the recreation vehicle are secure/tight/ready for travel. Periodically re-check the bicycles to make sure they are still securely fastened to the bike rack.

Know your recreation vehicles weight limitations prior to loading the bicycle rack. The weight of the bicycles should be included in the weight calculation when determining the maximum cargo weight load or your recreation vehicle.

TRAVEL TRAILER HITCH (page 13)

FIFTH WHEEL PIN BOX (page 14)

Using an oversized or undersized hitch can cause damage to the RV frame. We (as your RV manufacturer) cannot be responsible for the tow vehicle suspension system. The final ball height after the tow vehicle/travel trailer combination is completely hooked up is a factor that must be considered. To avoid overloading your trailer axles and minimize possible handling difficulties, your trailer should be level when hooked to your tow vehicle. Do not overload your tow vehicle.



SECTION 4: VEHICLE OPERATION



TOWING

⚠ CAUTION ⚠ **⚠ WARNING ⚠** (See page 32 & page 35)

Your RV will travel safely and comfortably at highway speed limits. It will take longer than a passenger automobile to reach that speed. Allow more time to go around vehicles you are passing. Avoid situations that might require sudden momentum changes as the length of the tow vehicle/RV combination affects your ability to quickly cut back into traffic. Swerves and sharp turns, especially at high speeds, could result in loss of control of the tow vehicle/RV. Slow down in advance of dips, bumps, and railroad tracks to reduce the jolting to your tow vehicle/RV combination. Proceed slowly and let the trailer tires pass over them before accelerating.

Adverse weather conditions and extremes in terrain may affect the performance and handling of your tow vehicle. Do not operate the tow vehicle cruise control on icy or extremely wet roads, winding roads, in heavy traffic or in any other traffic situation where a constant speed cannot be maintained.



When descending a long hill, make sure your tow vehicle is in tow/haul mode (if available) or drop down into a lower gear or range. Avoid conditions that require excessive and prolonged use of your brakes. Apply and release brakes at short intervals to allow them to cool. The tow vehicle transmission and engine will help in controlling downhill speed and can lengthen brake life. Use care when accelerating or decelerating on a slippery surface. Abrupt speed changes can cause skidding and loss of control.

Know the weight and size of your towing combination and observe any posted weight and clearance limits. The added height of roof air conditioners, TV antennas or floodlights may cause clearance problems around some tunnels, canopies, and hanging signs.

When turning, the tires do not follow the path of your tow vehicle tires. The RV will make a tighter turn than the tow vehicle. Compensate for this by carefully pulling the tow vehicle out further than you would normally so that the RV clears curbs and other items. Swerves and sharp turns, especially at high speeds, could result in loss of control of the RV.

If your camping destination does not have pull through sites, pick a level site and back in carefully. Check to ensure there are no obstacles in your path and that you have plenty of vehicle clearance.

Once the RV is in the desired location, set the tow vehicle parking brake. Chock all RV wheels securely to prevent it from rolling.

RV Brake System

Even though your RV is equipped with brakes designed for GVWR, proceed with caution until you become accustomed to your RV's stopping distance.

Driving through water deep enough to wet the brakes may affect stopping distance or cause the vehicle to pull to one side. Check the RV's brake operation in a safe area to be sure they have not been affected. **Never operate any vehicle if a difference in braking efficiency is noticeable.**

Electric Brakes

⚠ WARNING ⚠ (See page 32)

The electric brakes are designed to work with the tow vehicle brakes. **To maintain proper braking performance, both the RV and tow vehicle brakes must be used together. Separate use of the braking systems will cause accelerated wear and damage.**

When your RV is new, it is impossible to adjust the brakes precisely. It takes approximately 1,000 miles and/or 50 medium to heavy stops to seat the shoes to the brake drum. Once broken in, your brake shoes must be adjusted for best performance and increased durability.

Braking system components include:

- Tow vehicle battery
- Tow vehicle brake controller
- Wire harness/connector plug
- Trailer battery
- Breakaway switch and alarms

The tow vehicle battery is the primary source of power for your RV's electric brake operation. To ensure available power when needed, keep your tow vehicle battery and charging system working properly.

VEHICLE OPERATION

Brake controller (customer supplied)

A brake controller needs to be installed in the tow vehicle in order to make use of the RV electric brakes.

Consult with your dealer or the brake controller OEM to decide what is right for your towing combination.

Breakaway Switch

⚠ CAUTION ⚠ (See page 35)

Your RV may be equipped with a breakaway switch. The breakaway switch is a crucial part of the RV braking system. Located on the travel trailer A-frame, or beside the fifth wheel pinbox, this switch will apply the RV brakes if the trailer becomes detached from the tow vehicle. Attach the breakaway switch lanyard to a permanent part of the tow vehicle when hitching your RV. On a travel trailer, do not attach it to the hitch ball or similar removable parts. If the RV becomes detached from the tow vehicle, the pull pin will be pulled from the switch. This automatically causes the switch to “close” and activates the RV brakes. **A battery (customer supplied) must be installed to activate the breakaway switch.**

TOWING BEHIND YOUR RV

⚠ WARNING ⚠ (See page 32)

NOTE

A hitch equipped for trailer towing will have tabs to hang the safety chains and there will be a bracket for the trailer wiring plug. There should also be a label on the hitch stating maximum towing capacity. A hitch without these things is an accessory receiver and should never be used for towing. For more information see “CARGO CARRYING ACCESSORY RECEIVER (IF EQUIPPED)” on page 12.

FACTORY INSTALLED HITCH RECEIVER (IF EQUIPPED)

If your RV (applies to limited fifth wheel models only) is equipped with a factory installed hitch receiver, you have the ability to tow an additional boat or other watercraft trailer behind your RV.

The hitch receiver may be used as a weight carrying hitch to tow a boat or other watercraft trailer. Do not use a bar longer than 10” (254 mm). The maximum length of the draw bar is from the center of the fastening pin to the center of the ball. The maximum trailer tow rating of the fifth wheel hitch is 3,000 lbs. (1361 kg.) with a maximum tongue weight of 300 lbs. (136 kg.).

The receiver may be also used for attaching a cargo basket/carrier for other items. Ensure the cargo carrier is properly attached to the hitch receiver and all cargo is properly secured in place. The cargo weight carrying capacity includes the weight of the cargo carrier. The maximum total weight when used to carry cargo is 300 lbs. (136 kg.).

The trailer being towed by your RV must be properly equipped with brakes. Contact your tow vehicle dealer or manufacturer for assistance in determining whether a separate braking system is recommended and what the limits are for towing multiple trailer combinations. Check the state or province where your tow vehicle and RV are registered as well as any state or province where travel is planned in the U.S. and/or Canada for brake requirements and regulations.

Second Trailer Hitching Procedure

The following procedure will help to assist you in securely hooking up the second trailer to your RV.

1. Make sure the second trailer wheels are chocked.
2. Turn the tongue jack crank to raise the trailer tongue above the hitch ball.
3. Open the coupler latch on the trailer hitch.
4. Back the tow vehicle/ fifth wheel combination into the proper position.
5. Turn the second trailer tongue jack crank to lower the coupler onto the hitch ball.
6. Close the coupler latch after it is completely seated.
7. Remove the dolly wheel or platform (if equipped) and retract the tongue jack to its maximum height.
8. Attach the breakaway cable to the hitch receiver on the RV fifth wheel.
9. Attach the safety chains. See “Travel Trailer Safety Chains” on page 14 for additional information.
10. Plug in the wire harness/connector.
11. Walk around the RV and the second trailer making sure all exterior lights are working correctly.
12. Remove the trailer wheel chocks.

Wire Harness/Connector Plug

A 4-way wire harness/connector plug is wired into your RV to connect electrical power from the RV to the second trailer for travel. This supplies power to the taillights, clearance lights, turn signals, brake lights, etc. The 4-way wire harness/connector is not wired for operating electric brakes.



The connector plug may build up corrosion with extended use and should be cleaned periodically to insure good electrical contact. Make sure the connector plug is kept clean and protected from road elements as you travel.

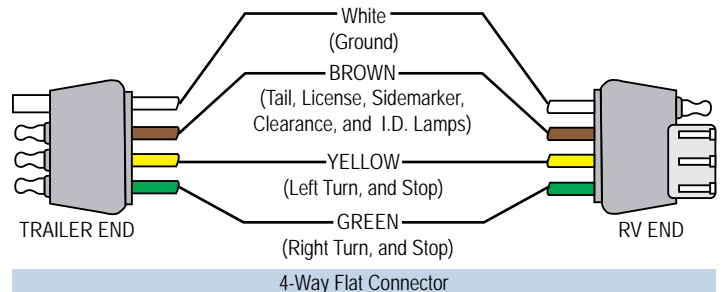

ENTRANCE DOOR STEP(S)

Make sure your entrance step is fully extended before exiting the vehicle, and retracted prior to towing.

Lubricating the step mechanism

Carefully clean the area around the pivot points (the rivets involved in the motion of the mechanism). Lubricate these pivot points with an automotive grade, non-staining lubricant every 30 to 60 days.

Wipe any excess lubricant off of the step and then clean the entire step after lubricating.

STEP LIGHT

Your RV may be equipped with a switch located on the skirt (in front of the steps) which operates a light located under the step assembly.

STOWABLE ENTRANCE DOOR STEP

⚠ WARNING ⚠ (See page 32)

Your RV may be equipped with one or two sets of stowable entrance steps. They are a one piece, 2 to 4 step assembly that latches inside the doorway of the RV. The steps rotate down and out of the doorway, and include two adjustable feet to provide stability while parked on rough terrain.

Step Operation

1. Open the entrance/screen door all the way.
2. Twist the locking handle to release the steps from the locked position on the door frame (A).
3. Lower the step assembly to the ground (B). If the step will not drop fully with the legs fully raised, you may need to dig out the landing area to help the steps clear the door.
4. Adjust the feet to stabilize the steps (C).
5. Remove pins (D) on each side of the step to adjust the legs, then reinsert the pins to lock the legs. If the feet do not reach the ground, use wood or stone blocks to achieve a firm and level contact.



NOTE

Depending on the model, the step adjustment pin may be located on the side of the step system, or on the front where each leg attaches to the side rails.

Step Storage

NOTE

When returning steps to the stored position, the adjustable feet may have to be retracted to fit inside the door opening.

1. Make sure that the RV is not currently occupied.
2. Fold the handrail at the door out of the way or remove the optional step handrail (if equipped).
3. Pull pins from adjustable legs (D), and retract the legs so they fit inside the doorway when steps are folded. Reinsert the pins to lock the legs.
4. Lift the steps and rotate up into the doorway.
5. Steps will automatically latch into brackets on each side of the door frame as they are lifted in place.
6. Close the entrance/screen door.

ENTRANCE DOOR

⚠ CAUTION ⚠ (See page 35)

Always hold onto the entrance door when opening or closing it. Damage caused because you failed to do so is not covered by the Limited Warranty.

The entrance screen door may be equipped with a slide panel that allows access to the entrance door handle and locks. The entrance door may also be equipped with both a regular door lock and a dead bolt lock.

Keys

Several keys are provided when you purchase your vehicle. Most keys have an individual key number stamped on the plate. Record these key numbers in the log below and in another safe place that you can access if locked outside of the vehicle. You can order a key blank from your dealer to have duplicate keys made. If you lose the keys, contact your dealer or a locksmith for assistance.

KEY LOG

Maintenance

Locks on entrance and baggage doors need biannual lubrication using a light coat of silicone spray. Conditions such as rain, salt, dust and pollution may increase the maintenance needs.



VEHICLE OPERATION

LEVELING SYSTEM (IF EQUIPPED)

⚠ WARNING ⚠ (See page 32)

The Leveling System is an electric 4 or 6-point automatic leveling control. The system utilizes one main control board and a separate waterproof remote level sensor to measure and manage level point. It can be operated by the **Auto Leveling Control Touch Pad** - Mounted outside the RV within view of the hitch.

Refer to the manufacturer's user manual included in your Customer Information Packet for complete safety and operating instructions.

Auto Leveling Control Touch Pad

A - Red/Green LED indicates system status

B - Up Arrow extends front jacks (landing gear)

C - Down Arrow retracts front jacks (landing gear)

D - Auto Level button places system in the auto level mode

E - Hitch Height button initiates the Hitch Recognition feature

F - Retract All button puts leveling system in full retract mode

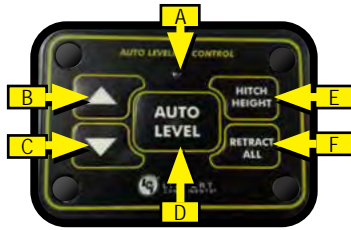

NOTE

Pressing both the arrow buttons simultaneously turns on the touchpad. Touchpad will time out after 7 minutes of non-use.

Auto Level Touchpad LED Indicator status

- **OFF** - Touch pad is locked
- **Solid Green** - Touch pad is active
- **Blinking Green** - Jacks are moving
- **Solid Red** - Low battery
- **Blinking Red** - Error

The OneControl touch screen or Leveling App will show the specific error.

Refer to troubleshooting section of the manufacturer's manual to clear the error.

Unhitching the RV

1. Before unhitching from the tow vehicle, ensure the RV is parked on a level surface and tires are chocked.
2. Extend the inner legs of both landing gear (front jacks) to within 4" - 5" of the ground by pulling on the quick release pins.
3. Turn on the touchpad by pressing both arrow buttons simultaneously. LED illuminates solid green.
4. Press the UP arrow button to extend the front jacks to lift the front of the RV taking weight off the hitch.
5. Uncouple the RV connection to the tow vehicle. Pull tow vehicle away.

Auto Leveling

When the leveling cycle has started, it is important there is no movement inside the RV until leveling is complete. Failure to remain still during leveling could affect the performance of the leveling system.

1. Turn on the touchpad.
2. LED will light up solid green.
3. Select AUTO LEVEL and the auto leveling process begins. Front of the RV will seek a position near level. Rear jacks will be grounded (on 4-point system). Side to side leveling will begin.
4. Each jack will perform a final grounding touch.

On a 6-point system, the (2) middle jacks will be grounded to stabilize the trailer. The (2) middle jacks do not level the RV.

If the AUTO LEVEL sequence does not perform as described above, place the system in manual mode and test that the jacks operate correctly by using the OneControl touch panel inside the RV.

STABILIZERS

⚠ WARNING ⚠ (See page 32)

Each stabilizer can be individually adjusted to stabilize the RV for use. Make sure the RV is level BEFORE using the stabilizers.

When setting up on soft ground, you may wish to place a wood pad or the equivalent under each stabilizer foot to help keep the stabilizer from sinking into the ground.

Manual Stabilizers (if equipped)

1. To lower each stabilizer, insert the crank onto the applicable stabilizer shaft.
2. Turn the crank clockwise to lower each leg until it contacts the ground and stabilizes the RV.

To raise each stabilizer, insert the crank onto the applicable stabilizer shaft and turn the crank counter-clockwise.

Jayco Rock Solid Stabilizer System (if equipped)

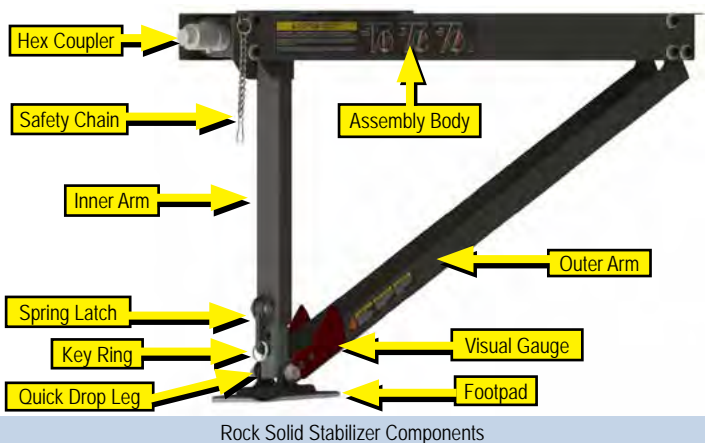

Extending Stabilizers

1. Disconnect the safety chain from the footpad (Fig. A).
2. Using a 3/4" socket on a ratchet or cordless drill, turn the hex coupler (Fig. B) clockwise to begin lowering the foot pad towards the ground.

NOTE

Use of an impact drill is not recommended and will cause damage to the mechanism.

3. After the footpad has extended to a point, it will be necessary to pull the spring latch (Fig. C) and lower the Quick Drop Leg so that the foot pad is positioned as close to the ground as possible.
4. Continue to turn the hex coupler clockwise until the footpad touches the ground and resistance is felt. It may take a few attempts of adjusting the Quick Drop Leg and turning the hex coupler to achieve the optimal stabilization (Fig. D). There should be a gap between the Visual Gauge and the Inner Arm if set correctly. You want the inner arm to be as close to 90 degrees (vertical) as possible.

NOTE

Upon completion, the inner arm should not have moved beyond a 90 degree angle; perpendicular to the assembly body. Doing so may cause the mechanism to bind and cause damage.

5. Repeat process for other stabilizer legs.



Retracting Stabilizers

To retract the stabilizers, reverse the process above, remembering to retract the Quick Drop Leg after raising the Foot Pad so the stabilizer does not stick out from the sides of the RV during transit, and re-attach the Safety Chain.



Electric Stabilizers (if equipped)

Control switches for the stabilizers are typically located on the (door) side of the unit above the stabilizer jack(s). To lower each stabilizer, press the control switch until each leg contacts the ground and stabilizes the unit. To raise the stabilizer, press the control switch until the stabilizer is returned to the retracted position.

Manual Override

The electric stabilizers may have a built in manual override system. The override coupler is located on the end of the stabilizer opposite the electric motor. One of the wire motor leads must be disconnected to prevent back loading the motor and causing more damage.

Disconnect the battery from the system prior to manual operation.

Insert the 1/2" diameter crank handle inside the coupler. The slot in the end of the crank handle accommodates the pin inside the coupler to allow manual extension/retraction of the stabilizer. Rotate the handle clockwise to retract and counter-clockwise to extend the stabilizer.

NOTE

The gears can be stripped out if the stabilizer is manually retracted/extended to its fullest extent and the operator continues to rotate the manual override.

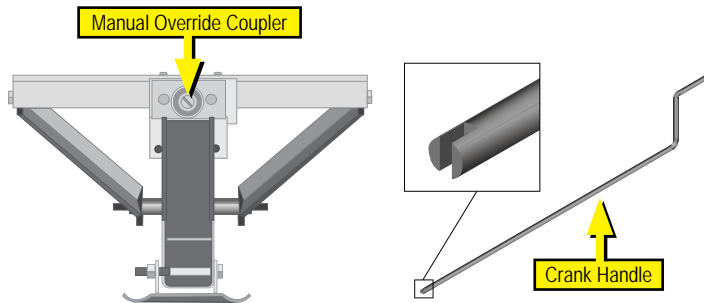

Electric Stabilizer Manual Override

TANDEM AXLE FLEX EQUALIZER (IF EQUIPPED)

Your recreation vehicle may be equipped with a tandem axle flex equalizer on the leaf spring suspension. These units may have grease zerks attached to the head, and should be greased approximately every 3500 miles. Check with the component manufacturer for additional information.

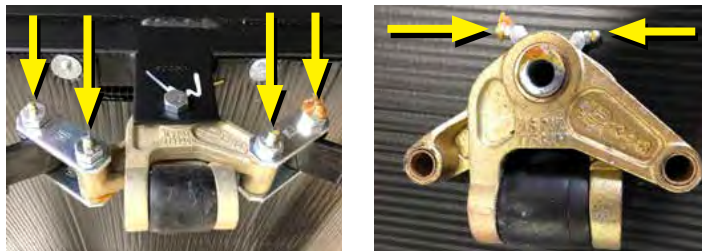

Example Tandem Axle Flex Equalizer Grease Zerk Points



VEHICLE OPERATION

EMERGENCY STOPPING

⚠ WARNING ⚠ (See page 33)

Always carry road flares or reflective warning signs. Pull off the roadway as far as possible for emergency stopping. Turn ON your vehicle hazard warning flashers. If traveling at night, use three red warning indicators such as flares, reflectors, or lanterns as required by the Uniform Vehicle Code and Model Traffic Ordinance.

NOTE

Curves and hills may affect the safe placement of warning indicators.

EMERGENCY TOWING

⚠ WARNING ⚠ (See page 33)

If your recreational vehicle needs to be towed, please contact an emergency road service provider or a qualified service facility for assistance.

WHEEL LUGS

⚠ WARNING ⚠ (See page 33)

After your first trip, check the wheel lug torque periodically for safety.

Lugs should be checked:

- After winter storage
- After a wheel removal
- Before starting a trip
- Following extensive braking

Lug nuts should be tightened in two stages. Lugs should be started by hand, then torqued to intermediate values (Stage 1) on the chart then torqued according to the final torque values on the chart.

- Use the correct star pattern sequence to attach the recreation vehicle wheels.
- Start all nuts by hand to prevent cross threading.
- Tighten the nuts in the sequence shown.

NOTE

The proper method of tightening wheel lug nuts is with a properly calibrated torque wrench and socket, not with an impact wrench or by hand. Do not use a 4-way lug wrench or any other type of wrench that does not measure the actual pressure applied to the lug nut. Lug nuts should be tightened according to the proper lug pattern on your wheels. Refer to the Wheel Lug Nut Diagram below.

Wheel Lug Nut Diagrams

Because of the importance of having proper torque on the wheel lug nuts, you should always have the wheels mounted and properly torqued by a qualified technician using the proper tools.

Criss cross "star" patterns, as shown, must be followed during tightening sequence.

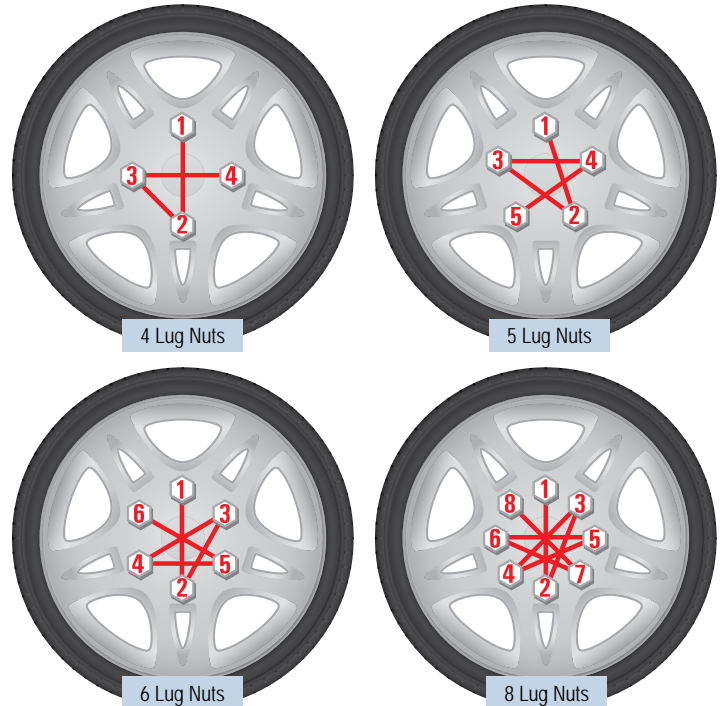

A Digital or Dial Torque Wrench is recommended.

Also applies to any service involving wheel or lug removal, during the life of the recreational vehicle. Start the lug nuts by hand.

Wheel Lug Nut Torque Values

⚠ WARNING ⚠ (See page 33)

Lug Nuts	Stud Size	Rim Size	Rim Type	Stage 1 Torque Values	Final Torque Values
4-Lugs	1/2"-20	12"	Steel/Alum	45 ft lbs	70 ft lbs
5-Lugs	1/2"-20	12"-13"	Steel/Alum	45 ft lbs	70 ft lbs
5-Lugs	1/2"-20	14"-15"	Steel/Alum	65 ft lbs	120 ft lbs
6-Lugs	1/2"-20	15"-16"	Steel/Alum	65 ft lbs	120 ft lbs
8-Lugs	1/2"-20	16"	Steel/Alum	65 ft lbs	120 ft lbs
8-Lugs	9/16"-18	16"	Steel/Alum	65 ft lbs	120 ft lbs



Lug Nut Pattern and Warning Label

The following labels showing the proper lug nut tightening pattern and a warning label are located on the driver side front or front sidewall on travel trailers, and on the driver side of the pinbox on fifth wheel units. Lug pattern label will vary according to number of wheel lugs.



Torque Wrench Usage

1. Tools should be maintained, in good condition, and stored appropriately.
2. Do not use accessories or handle extensions unless specifically allowed by the torque wrench manufacturer.
3. Apply torque in a slow, steady manner *in a downward direction* and avoid sudden "jerking" movements.
4. When the wrench signals (by clicking, beeping, or lights) that a specific torque has been reached, stop immediately.



"Keep your air pressure checked, while you are traveling, at least once a week."

Randy Zonker,
Jayco Tech Training Manager
[WINGMATE AP]

TIRES

CAUTION (See page 35)

Read and understand the following before taking your first trip in your RV.

Routine maintenance on your RV is important. To ensure your tires are operating safely, regular inspection of the tires and checking tire pressures is absolutely mandatory.

Alignment, balance and bearing wear will affect tire wear. Make sure to look for cracking, bulging, uneven tread wear, etc.

Tire Wear Diagnostic Chart

Center Wear	Edge Wear	Side Wear	Toe Wear	Cupping	Flat Spots
Cause					
Over inflation	Under inflation	Loss of camber or overloading	Incorrect toe-in	Out of balance	Wheel lock-up & tire skidding
Action					
Adjust tire pressure to particular load, per tire catalog.	Adjust tire pressure to particular load, per tire catalog.	Insure load does not exceed axle rating. Align at alignment shop.	Align at alignment shop.	Check bearing adjustment & balance tires.	Avoid sudden stops when possible and adjust brakes.

Tire Pressure

DANGER WARNING (See page 32 & page 33)

You must follow the manufacturer's inflation guidelines for maximum load capacity. Under-inflation is just as dangerous as over-inflation.

Proper inflation should be monitored closely.

Failure to do so could result in the overheating of a tire causing a blowout. Inflation pressure should be as recommended by the tire manufacturer or as the federal label for the recreation vehicle indicates.



When you are using your Recreation Vehicle, check inflation pressure weekly. Pressure should be checked when the tires are cold. During travel, tires heat up and pressure increases. Do not bleed air from hot tires or your tires may then be under-inflated.

NOTE

Cold tire inflation pressure is defined as a tire that has not been used for three or more hours, or has been driven less than one mile. Tire inflation pressure of a hot tire may show an increase of as much as 6 psi over a cold tire.

VEHICLE OPERATION

TIRE PRESSURE MONITOR SYSTEM (TPMS) (IF EQUIPPED)

⚠ WARNING ⚠ **⚠ CAUTION ⚠** (See page 33 & page 35)

Your RV may be equipped with a Tire Pressure Monitoring System (TPMS). The system has sensors installed on the tire valve stems. Tire temperatures and pressures are displayed only on the JayCommand/TravelINK Smartphone App, which connects through Bluetooth to your BMPRO control system. There is no TPMS page on the BMPRO Mini control panel screen inside the RV.

Rotating the tires:

The TPMS System comes with sensors that either screw on to the valve stem or are inside the stem of each tire. Screw on sensors are programmed according to their tire position on the trailer, and not to each individual tire. Make sure the screw on sensors stay in the same location during a tire rotation.

Internal sensors are paired to each tire. To change the pair position in the JAYCOMMAND/TravelINK Smartphone App, go to the sensors page in the phone App or touch screen (if available), and unpair all tires. Then, for each tire, one at a time, choose pair, then follow the onscreen instructions to pair each tire.

CHANGING A TIRE

⚠ WARNING ⚠ (See page 33)

If you experience a flat tire on your recreational vehicle while driving, gradually decrease your speed and move the recreational vehicle to a safe, level place on the side of the road.

1. Keep the recreational vehicle attached to the tow vehicle. Chock the tire on the opposite side of the recreational vehicle from the tire you are changing.
2. Loosen the wheel lug on the tire you are changing before jacking up the vehicle. DO NOT remove the lug nuts; only loosen them for ease of removal when the tire is off the ground.
3. Place the jack (hydraulic or screw) under the main frame rail of the RV (it spans from front-to-back just inside the tires). It must be just ahead of the front tire or just behind the rear tire. Use the jack to lift the tire off the ground.
4. Remove the lug nuts, and replace the tire.
5. Hand tighten the lugs, and lower the jack. With the tire on the ground, fully tighten the lugs using the appropriate torque pattern and values.
6. Remove the chocks, and store the damaged tire until it can be fixed or replaced.

Tire Replacement

Any service or warranty coverage on tires is to be handled by the tire manufacturer or the store representing the brand installed on your recreation vehicle. They are not to be returned to your dealer or recreation vehicle manufacturer.

If you have questions regarding your tires, contact the tire manufacturer.

SPARE TIRE CARRIER (IF EQUIPPED)

⚠ WARNING ⚠ (See page 33)

If your recreational vehicle is equipped with a spare tire, it will either be mounted under the unit (hoist) or on the rear bumper.

Hoist Mount

The spare tire will be mounted against the underside of the recreation vehicle (flush mount) using a cable hoist to give it stability in travel.



NOTE

If your spare tire is a flush mount application, it must make contact with the underside of the recreational vehicle to insure maximum road clearance and stability in travel.

Raising and lowering the hoist

The crank handle to raise and lower the tire will be located in the storage under the master bed or in a basement compartment of the recreational vehicle. Insert the crank handle into the crank access port (A) located either in the center of the rear bumper, or on the sidewall of the RV. You may find it easier to look/feel under the skirting to align the handle with the attachment point.



Turn the crank handle to raise/lower the tire. Visually inspect to insure the proper seating of the tire for travel. The hoist lift (B) should sit firmly in the center of the tire.



NOTE

If the manual crank access port is located in a slideout, the slideout room must be in the travel position (in) to allow the crank to reach the mechanism used to raise or lower the tire.

Rear Bumper Tire Carrier

1. Remove the spare tire cover (if equipped).
2. Remove the lug nuts holding the tire in place.
3. Remove the support bracket from the bottom lug.
4. Pull the tire from the tire carrier.

To reinstall the spare tire, reverse the steps above.

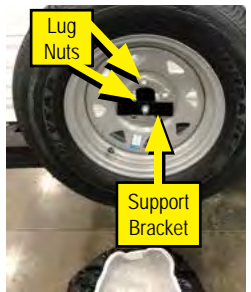

Bumper Mounted Spare Tire

Vinyl Tire Cover (if equipped)

Your tires are manufactured with components that cause "bleeding" onto the tire cover. To prevent this, it is recommended to use a separator (garbage bag, paper, cloth, etc.) between the tire and the cover.

VEHICLE OPERATION

SETTING UP YOUR RECREATION VEHICLE

⚠ CAUTION ⚠ (See page 35)

Position the RV as desired in a location that is mostly level from side to side, has clearance for slide-outs, allows for clear and solid placement of stabilizer and tongue jacks, and allows for safe movement around the outside of the vehicle.

Level the RV (side-to-side). Leveling your recreation vehicle is important as the water drainage systems are designed with proper slope and must be level for proper operation, and the appliances perform best when level.

Travel Trailer Set Up

1. Make sure the tow vehicle is in park, and chock the wheels securely to prevent the RV from moving.
2. Unhook the wire harness/connector plug, safety chains, and breakaway switch lanyard.
3. Install the dolly wheel or platform.
4. Release the weight distributing bars (customer supplied).
5. Open the tongue jack coupler latch.
6. Raise the tongue jack to lift the coupler above the hitch ball.
7. Pull the tow vehicle away.
8. Level the RV (front-to-back) with the tongue jack.
9. Extend slide outs then lower the stabilizer jacks.

Fifth Wheel Set Up

1. Make sure the tow vehicle is in park, and chock the wheels securely to prevent the RV from moving.
2. Lower and secure the landing gear.
3. Lower the tailgate.
4. Raise the landing gear so the weight is off of the hitch plate. There should be a small gap (about 1/8") between the pinbox and the receiver.
5. Gently put your truck into reverse (do not give it any fuel/acceleration). This effectively moves the kingpin off the locking bar that will allow you to disengage it.

6. Step on brake, put the vehicle in park, and apply parking brake.
7. Disconnect the wire harness/connector plug and breakaway switch lanyard. Stow them out of the way.
8. Disengage the locking bar and unhitch.
9. Pull the tow vehicle away.
10. Adjust the landing gear height for proper front to back leveling of the RV.
11. Extend slide outs and then lower the stabilizer jacks.

CAMPSITE HOOK-UP

- Refer to "SECTION 6: ELECTRICAL" on page 38 before connecting the shore line power cord (when using full hook-up) OR before starting the generator (if equipped) or operating the vehicle on 12-volt power when dry camping.
- Refer to "SECTION 7: FUEL & PROPANE SYSTEM" on page 55 before using the LP system. Open the LP gas tank valve (if equipped) slowly. There may be air in the lines and five to thirty seconds of time is needed to bleed air before LP vapor fills the lines.
- Refer to "SECTION 8: PLUMBING SYSTEM" on page 61 before connecting the fresh water supply or turning ON the water pump or water heater.
- When using full hook-up, connect the sewer hose to the campsite sewer hook-up.
- If applicable, start the refrigerator and the cooling or heating system.



NOTE

For extended dry camping, management of all your resources is essential. Check your battery levels and conserve battery power.



VEHICLE OPERATION

SEASONAL SET-UP (BUNGALOWS ONLY)

If you are setting up in a seasonal campsite, consult your authorized dealer for guidelines in properly setting up your bungalow travel trailer. Proper set up will insure your safety along with getting the most effective use from your RV and its features.

You should also familiarize yourself with all site requirements and local zoning ordinances that may apply.

When setting up your seasonal campsite make sure:

- The campsite is properly graded and sloped to prevent water accumulation under the travel trailer.
- All load bearing supports and footings meet the local enforcement agency requirements for size, capacity and application.
- Grass and organic material from the area is removed from under supports or footings.

Frame Support

The bungalow may rest on the tires and hitch jack as needed, but for long term use where you might want a more stable base, additional frame supports will be needed to isolate the frame from the suspension. **PROFESSIONAL INSTALLATION IS HIGHLY RECOMMENDED.**

The following process can be used when placing the unit on a site that has been designed for the location of an RV where either a Concrete Slab, Pier, or Footing has been provided. In areas where these foundations have not been provided, the ground conditions need to be adequately evaluated and a determination needs to be made regarding the load bearing capacity and possible improvements that may be needed.

1. Locate the trailer in its final position and chock the tires securely.
2. Place a level on the floor in the unit running front to rear and use the hitch jack to bring the unit to a level position.
3. Turn the level 90 degrees to run from side to side on the unit floor.
4. On one side of the RV, using 2 hydraulic jacks with a minimum load capacity of 5 tons (user provided), place one jack under the frame, forward of the front spring hanger and the other rearward of the rear spring hanger.
5. Begin lifting the unit using the hydraulic jacks alternately lifting no more than 1" on each jack. Place support piers forward and rearward of these jacks placing hardwood cribbing to within 1/4" of the I beam for each pier.

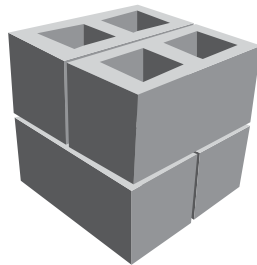

Concrete Block Pier Example

NOTE

We recommend using 8"x8"x16" concrete blocks stacked alternatively for use as piers. Use hardwood cribbing to fill the gaps between your piers and the frame.

6. Lower the hydraulic jacks so the I beam rests on the hardwood cribbing.
7. Locate the two hydraulic jacks on the opposite side of the unit in the same relative locations, forward and rearward of the spring hangers. Begin lifting the unit up alternately using the jacks, lifting no more than 1/2" at a time on each jack. Bring the unit to a position that is level as indicated by the level placed on the floor of the unit.
8. Raise each jack an additional 1". Place piers and hardwood cribbing in the same manner with the cribbing brought to 1" from the I beam. Lower the hydraulic jacks so the I beam rests on the hardwood cribbing.
9. Turn the level to its original position running front to rear in the unit and make any minor adjustments to level with the hitch jack if needed.
10. Additional Piers should now be located under the I beams at the front and rear of the unit within 3 feet of the end of the I beams. The jacks can be used to lift the I beams up a small distance so that the cribbing can be placed on top of the piers and the jacks lowered to rest securely on the supports at the front and rear with the loads transferring into the added piers.

NOTE

It is not necessary to lift the RV tires off of the ground or remove them. If the RV tires are removed, additional supports will need to be installed under each axle.

Tie-downs

All bungalow travel trailers should be securely anchored to the ground with (6) tie-downs and ground anchors (minimum 3 per side), to resist the sliding and overturning effects of high winds. Where tie-downs are required, it will be necessary to adhere to the following instructions.

All bungalow travel trailers are equipped with tie-down attachment provisions on the main "I"-beams. Any one of the three methods featured may be used.

In the tie-down system, it is important to use materials of proper design and adequate quality. The following material specifications should be considered as minimum requirements.

The following materials, not furnished with the travel trailer but are necessary to complete the tie-down system, **must meet the listed requirements.**

1. Cable or steel strap with a breaking strength of at least 4,725 lbs., e.g. galvanized aircraft cable at least 1/4" in diameter or Type 1, Finish B Grade 1 steel strapping, 1 1/4" wide and 0.035" thick, conform to F.S. QQ-S-781-H.
2. Galvanized connection devices such as turnbuckles, eye bolts, strap buckles and cable clamps should be rated at 3,150 lb. working load minimum.

VEHICLE OPERATION

- Ground anchors capable of withstanding at least a 4,725 lb. pull. **Anchors must be installed as specified by the anchor manufacturer.**

THE UNIT MUST BE IN ITS FINAL LEVEL POSITION PRIOR TO TYING IT DOWN.

Leveling your recreation vehicle is important as the water drainage systems are designed with proper slope and must be level for proper operation, and the appliances perform best when level.

The procedure for tying down the travel trailer is as follows:

- Position and install the ground anchors to line up with the provided tie-down brackets.
- Connect the straps to the frame and ground anchors.
- Tighten the straps using the tensioning device provided with the ground anchors. Use caution to avoid over-tensioning the straps as this may pull the trailer off the piers. Straps should be tightened only enough to remove the slack. **After all the straps are installed and the slack removed, tension the straps.**

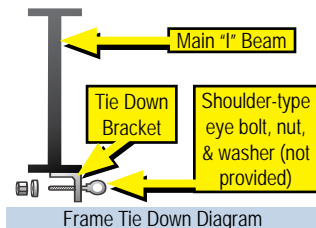

The strap tension should be rechecked at frequent intervals until all pier settlement has stopped.

During the re-leveling process, do not jack the travel trailer against tight straps.

Inspection Checklist

Once the bungalow travel trailer has been set up for long term seasonal camping, the following items should be checked for proper set up prior to occupancy.

- Installation / Placement
- Utility Connections
- Level
- Fuel
- Foundation
- Water
- Tie Downs
- Electric
- Sewage

Detachable Hitch

Some units come with a detachable hitch. If detachable, the hitch A-frame will be bolted to the underside of the trailer frame. The instructions to remove and install it are listed below:

SUGGESTED MATERIALS (CUSTOMER SUPPLIED):

Quantity	Item Description
4	3-ton jack stands
2	7/8" open end wrench
1	3/4" socket and drive
1	3/8" socket and drive
4	Wood blocks or tire chocks

- Chock tires on both sides of trailer.
- Unscrew flexible gas hose from main bulkhead on front steel crossmember and cap both fittings.
- Remove gas bottles from tongue.
- Remove electrical wiring and safety break-a-way switch from tongue by removing 3/8" screws (could be 3 or more).
- Coil wires up and place behind front crossmember.
- Raise tongue up with tongue jack.

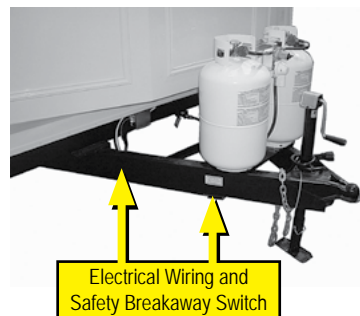

Detachable Hitch

- Place 2 jack stands (3-ton minimum rating each, one on each side of the trailer) approximately 4' behind the front crossmember under the main I-beam.
- Lower frame down onto jack stands.
- Place another (2) jack stands (3-ton minimum rating each, one each side of tongue) under tongue between (2) tongue connection plates.
- Remove tongue from trailer by removing 3/4" bolts and nuts (4 per connection plate, 16 total).

To reinstall the hitch, reverse these steps (tighten the bolts to 60-70 ft/lbs torque). It is your responsibility to take your travel trailer to the dealer for warranty or service repair.



VEHICLE OPERATION

CARGO RAMP DOOR

⚠ WARNING ⚠ (See page 34)

The cargo ramp when used as a ramp or a patio has a **maximum weight/occupancy capacity that is listed on decals on or near the ramp**. Do not exceed these ratings at any time.

The cargo ramp door is spring assisted to aid in opening and closing the ramp door.

Select a site for unloading that will provide a level/flat surface for the ramp door to rest on. Make sure the RV wheels are chocked to prevent the trailer from moving. Make sure there are no people, pets, or equipment in the way when opening the ramp door.

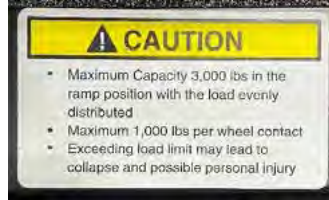

Ramp Weight Warning Decal Examples

Manual Ramp Door

1. Lessen the transition angle between the rear of the cargo floor and the cargo door ramp by using the tongue jack to raise the front of the trailer. To prevent damage to the ramp door and extension ramp this should be done prior to lowering the cargo ramp door.
2. Unlock the Tailgater Kitchen (if equipped) and swing it away from the rear ramp door.
3. Unlock the exterior vise latches securing the bar latch handles.
4. Push up on the bar latch handles that hold the ramp door in place, and move them to the outside of the trailer to avoid contact when opening the ramp door.
5. Using caution, pull the ramp door open. Support the ramp door at all times and do not let it drop to the ground.

NOTE

For automated ramp doors (if equipped), turn the keyed power switch ON, then press and hold the momentary switch to lower the door.

To close the manual ramp door

As the trailer is being loaded, make sure that stored vehicle(s) and/or equipment do not damage the ramp door seals. Remove any debris (sand, snow, etc.) from around the ramp door before closing it. To close the ramp door, reverse the above process. Secure the ramp door by locking the vice latches.

NOTE

Do not move the RV until the cargo ramp door is closed and secured.

Manual Ramp Door Support Cables

The manual ramp door can be closed with the patio support cables attached to the ramp door and the door frame. Inspect all ramp door components each trip for wear or damage. Contact your RV dealer for a service appointment if repairs are needed.

Automated Ramp Door (if equipped)

Your RV may be equipped with an automated ramp door. Follow all precautions and warnings listed previously for the manual ramp door.

Exterior Keyed Switch

The automated ramp door is operated with a keyed switch located on the outside of the RV (off door side) next to the shore power plug. Insert the key in the key switch and turn it ON.

Press and hold the momentary switch down to lower the ramp door. The switch must be held until the door is completely lowered. If you release the switch, the door will stop until the switch is pressed and held again.



Keyed Switch

With the key ON, press and hold the momentary switch UP to raise the ramp door. When the ramp door is closed, release the switch and turn the key OFF.

Automated Ramp Door Support Cables

⚠ WARNING ⚠ (See page 34)

The cables used to hold the ramp door in the patio configuration **MUST** be removed from the door when not in use. If the cables are not removed when the door is closed, they will interfere with the door latch mechanism preventing the door from closing and possibly damaging the mechanism.

Remove the top end of each cable by releasing the quick links (A) holding it to the door frame. Unscrew each quick link and remove the cable and the quick link together from the top of the door on each side. **DO NOT LEAVE THE QUICK LINK ON THE DOOR FRAME.**

To release each cable at the side of the ramp door, unclip the safety pins (B) and slide the pin out of the door bracket. **DO NOT PUT THE SAFETY PIN BACK IN THE DOOR BRACKET.**

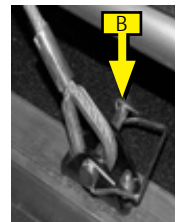

LOADING THE CARGO AREA

⚠ WARNING ⚠ (See page 34)

To assure safe towing and travel, it is important the proper attention be given to loading the cargo area. Caution should be taken not to exceed the weight capacity of the cargo ramp, cargo area and the GVWR of the RV. It is also important to make sure you comply with all towing requirements of your tow vehicle. Refer to the tow vehicle's owner's manual for towing requirements.

Weight Distribution

It is important to evenly distribute the load when loading the cargo bay area. Failure to do so could adversely affect the towing and handling of the RV.

The following guidelines must be used when loading the cargo area of the RV.

- Load the cargo bay from front to back, keeping heavier vehicles/items to the front of the cargo bay area.
- Load all vehicles/equipment evenly from side to side in the cargo bay.
- Secure all vehicles/items to prevent load shifts during transit.
- After loading, weigh the trailer at the hitch, each axle, and each wheel. Observe all trailer gross, axle, and tire ratings.
- If the weight of the loaded trailer exceeds any of the ratings as listed on the certification label located on the front lower left outside wall, remove or re-distribute the cargo load until the weight(s) are less than the maximum ratings.

Make sure all vehicles/items in the cargo area have been secured with the proper tie down straps and the cargo door is locked prior to transit.

Air Vents

Typically (2) air vents are located on either side of the cargo bay and are designed for airflow and ventilation when there is fuel powered equipment in the cargo bay. **The vents must remain open any time equipment is loaded in the cargo bay, including during travel.**

NOTE

Both vents should be open to prevent gas fumes from building up in the recreation vehicle. The upper vent should be positioned to draw air into the unit, and the lower to direct the air out when the unit is in motion.

To open the vent(s), firmly grasp the vertical bar in the middle of the vent, and push or pull it to the left or right until it clears the notch in the pivot base as shown below and the vent will open. To close it, pull the handle until it returns to the center of the pivot base.

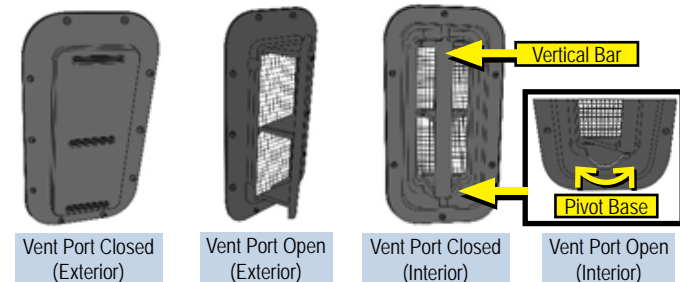

PATIO DECK - REAR (IF EQUIPPED)

⚠ WARNING ⚠ (See page 34)

Unlatch and swing the Tailgater Kitchen (if equipped) (attached to the rear of the RV) out of the way to lower the rear ramp door. (Refer to "TAILGATER CAMP KITCHEN (IF EQUIPPED - SEISMIC)" on page 85).

Manual Ramp Door

Patio support cables are attached to the ramp door and door jamb. The door is made to close with the support cables attached. The support cables must be detached from the door so it can be lowered and used as a ramp. Re-attach the support cables before closing the ramp door.



Automated Ramp Door

⚠ CAUTION ⚠ (See page 35)

The RV needs to be level, and the patio support cables **MUST** be detached from the ramp door and the door frame before the ramp door can be closed. This includes the quick links on the door frame, the safety pins on the ramp door, and the cables themselves.

Set up the Patio Deck (Automated Ramp Door)

Locate and secure the cables to both sides of the door frame and cargo door, by fastening one end of the cable to the top of the door frame using a quick link fastener. Tighten the nut on the quick link fastener once the cable is in place. Lifting up the door slightly, secure the other end of the cable to the cargo door by inserting the safety pin through the bracket and cable. Secure the safety clip on the end of the pin. Repeat the process on the other side of the door.

Side Rail Setup for Manual and Automated Doors

⚠ CAUTION ⚠ (See page 35)

To set up the side rails, remove the safety pins (2 per post) from the bottom of the rail posts. Lift the rail to the upright position and secure it in place by inserting a safety pin through each hole in the bracket and the rail. Secure the triangular wire safety clip on the end of each pin. Repeat the process on all corner rail posts.

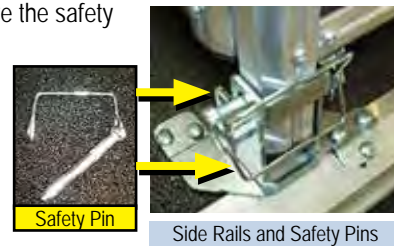

The patio deck is equipped with mesh end curtains that snap to the door jamb of the rear cargo ramp door (or the side patio door jamb) and to the frame work of the railings. These curtains close off the gap between the railing and the door jamb.



VEHICLE OPERATION

Retractable Screen Wall (if equipped)

Before extending the screen wall, remove all obstacles from its path. To extend the screen wall, grip the strap attached to the pull bar and gently pull down. Grasp the screen wall by the pull bar and continue pulling until it is completely extended. Make sure it is securely attached to the floor catch.

To return the screen wall to the stored position, pull up on the pull bar handle to release it from the floor catch. Push the screen wall up until it is fully retracted.

To avoid injury or damage to the screen wall, make sure it is fully extended and snapped in place at the floor when in use, and fully retracted when not in use.



Retractable Screen Wall

Sliding Rear Screen Door (if equipped)

The two center doors slide back behind the outer doors to allow walk out access to the deck. The screen doors incorporate a swing out feature to allow loading of vehicles in the cargo bay. To operate this feature, pull down on the (spring-loaded) handle, which unlocks the doors from the door frame.

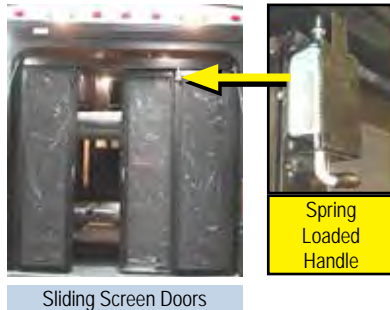

Sliding Screen Doors

They can now swing out over the ramp door. Once the vehicle is loaded, swing the doors back in place against the door frame, and re-latch the spring loaded handle.



PATIO DECK – SIDE (IF EQUIPPED)

⚠ WARNING ⚠ **⚠ CAUTION ⚠** (See page 34 & page 35)

To set up the patio deck, unlatch the two keyed handles from the side of the RV (Fig 4). Lower the patio deck until the cables on each side support it. Support cables are attached at the top of the door opening with a quick link (Fig 1) and to the deck with a safety pin (Fig 3). The patio deck is designed to be folded up with the support cables attached.

To set up the side rails, lift the (3) rails into their vertical positions. The rail supports drop into a slot on the deck mounted brackets (Fig 5). The front railing attaches to the side railing with a ball and socket connector (Fig 6). The deck's front gate has a pivoting bracket to latch the gate. This bracket latches over a metal pin (Fig 7).

The patio deck comes equipped with mesh end curtains that snap to the door jamb of the patio deck and to the frame work of the railings. These curtains close off the gap between the railing and the door jamb (Fig 8).

Before returning the patio deck to the stored position, the rails must be lifted up to release them from the locking slots in the mounting brackets, and then they can be laid down on the deck.

Fig 9 shows the complete patio deck with the optional step ladder.

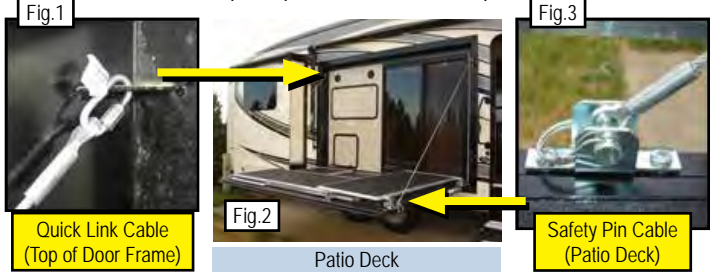

Quick Link Cable (Top of Door Frame)

Patio Deck

Safety Pin Cable (Patio Deck)

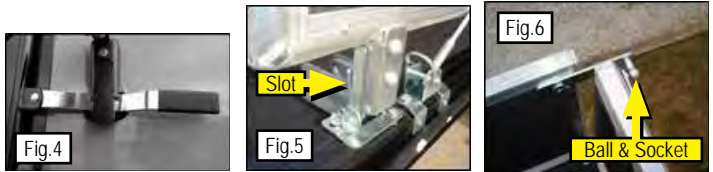

Latch Handle

Side Rail and Bracket

Ball & Socket

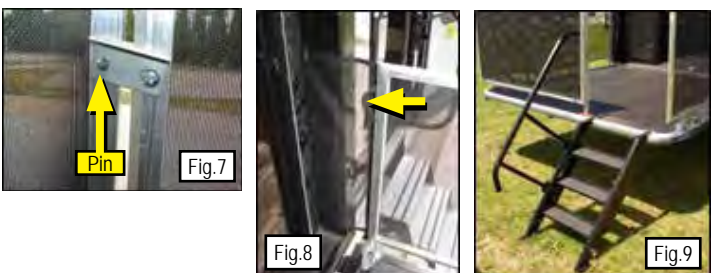

Pin

Fig.8

Fig.9

“We like to take our Jayco Toy Hauler out here, packed with bikes and friends, and ride around together”

Taylor
[California]

AWNINGS (IF EQUIPPED)

⚠ WARNING ⚠ **⚠ CAUTION ⚠** (See page 32 & page 35)

Awning Care

Keep your awnings clean and in good condition to prevent costly repairs.

- Keep the awning fabric clean. For detailed cleaning information, refer to the manufacturer's owner information.
- Do not use insecticides or other sprays near the awning fabric. These can cause stains, and could adversely affect the fabric's ability to repel water.
- Do not expose the awning to adverse environmental conditions, corrosive agents, or other harmful conditions.
- Do not allow the corner of the entry door to contact the awning fabric, otherwise premature wear or tearing of awning fabric could occur.
- Never close the awning (for storage) when wet. The combination of moisture and dirt could result in mildew, discoloration, and stains. If it is necessary to roll up awning (temporarily) while it is wet, make sure you roll it out and let it dry (as soon as conditions allow) before rolling it up again.
- Do not allow dirt, leaves, or other debris to accumulate on the awning, which could cause abrasion and stains. Mildew could grow on dirt and organic debris, causing permanent discoloration, stains, and odors to the awning fabric.
- Do not use strong chemicals or abrasives to clean parts, as their protective surfaces will be damaged. Clean awning hardware (as needed) with a mild surface cleaner.
- Apply silicone spray lubricant as needed to the moving parts on the fabric roller tube assembly.
- Lubricate all pins and sliding surfaces of the arm assemblies with silicone spray, as needed.
- Do not use abrasive or corrosive cleaners, mildew removers, or hard bristle brushes on the awning fabric.



Vinyl awning fabric is durable and water resistant. Wrinkling is a normal characteristic, which may be more noticeable when the awning is retracted and after prolonged periods of stowage (rolled up). Leave the awning open during warm weather to minimize wrinkling. A slight "travel line" may appear where the door roller (if installed) contacts the fabric. This is normal and does not affect the integrity of the fabric.

To clean the fabric:

- Open the awning.
- Mix 1/4 cup soap with five gallons of fresh water. Always use a natural soap, not a detergent. The water should be cold to lukewarm, never more the 100° F.
- Liberally drench the fabric with cleaning solution.
- Close the awning and allow the solution to soak for five minutes.
- Open the awning and thoroughly hose off the top and bottom of

the fabric with clean water. Repeat if necessary.

- Remove the solution COMPLETELY from the awning fabric.
- Make sure the fabric is dry before closing the awning. Air-dry only. Never apply heat to the fabric.

Power Awnings (if equipped)

NOTE

Electric awnings require connection to a 12-volt power source. Make sure you have sufficient power available before operating your awning (see "APPROXIMATE ELECTRICAL LOAD RATINGS" on page 48).

Your recreation vehicle may include one or more of the following options:

- Power window awnings
- Slide out awnings
- Power awning over entrance door

Power switches to operate the awnings are typically found in the control panel above the entrance door, or control may be found on the RV's touchscreen or through the JayCommand/TravelINK phone app (If equipped)

Each power awning will have its own control switch. Pressing and holding the switch will extend or retract the awning. The awning should automatically stop when the switch is released.

NOTE

Do not overextend the awning. If the awning or awning skirt show signs of overextending, retract the awning until it is in the appropriate position.

- Most power awnings give you the ability to adjust the awning pitch (slope). This will help with water runoff and pooling. When adjusting the awning scope, be aware of entrance door and window clearances. Coming into contact with a door or window can damage or tear the awning fabric.
- Before retracting the awning, make sure there is not pooled water or debris on the awning.
- When preparing to travel, make sure the awning is completely retracted and secured. Turn off any light strips (if applicable).
- Make sure all power sources to the awning have been disabled. Test the awning prior to leaving to make sure it does not extend.

Most power awnings have a manual override in the event the awning will not retract.

Refer to the manufacturer's user guide for detailed safety, operating and troubleshooting information.

In Motion Detector (if equipped)

Some patio awnings are equipped with a motion detector. If the patio awning experiences extreme or excessive movement, it will automatically retract to the travel mode position.

For detailed safety and operating information, refer to the manufacturer's user guide.



TIRE PRESSURE (page 23)

Failure to follow proper inflation guidelines may result in tire failure which, under certain circumstances, can cause loss of vehicle control or accidents that may result in property damage, bodily injury, and/or death.



TOWING (page 17)

Your RV braking system is rated for operation at GVWR not GCWR.

Whenever possible, do not travel with waste in the holding tanks. Liquid or debris in the holding tank(s) may affect the towing characteristics and may result in property damage or personal injury.

The propane cylinder(s) should be turned off when traveling. Most refrigerators will keep food cold or frozen for eight hours without running while you travel.

ELECTRIC BRAKES (page 17)

Failure to maintain the brakes in proper working condition as specified in the operator's manual supplied by the axle OEM will cause property damage, personal injury, and possibly death. Consult with your dealer for assistance.

TOWING BEHIND YOUR RV (page 18)

If you do not have a Jayco factory installed hitch receiver, towing items behind your Jayco RV, overloading the rear, or failure to adhere to the specified weight capacities will void the warranty and may result in: damage to the RV or add-on items, towing difficulties, property damage and/or personal injury.

The hitch receiver installed on your RV is a weight carrying hitch only. Do not use weight distribution bars or equipment when towing. Using weight distribution bars or equipment with the hitch receiver will void the warranty and may cause damage that could lead to adverse trailer combination towing and handling, loss of control, or an accident resulting in death or serious injury.

STOWABLE ENTRANCE DOOR STEP (page 19)

Maximum Weight Capacity 500 lbs.

Maintain hold of the steps until lowered all the way to the ground.

Prior to use, legs must be adjusted properly to ensure the step is level.

Ensure that both latches are engaged when the steps are stored.

Do not try to lift the steps while the door is closed. This may cause damage to the steps and the door.

Make sure people and pets are clear of the area when rotating the steps down to the ground or raising them for storage.

Failure to follow these guidelines could result in property damage or serious injury.

AWNINGS (page 31)

Awnings must be closed (and secured) while the RV is in transit.

Keep clear of arm assemblies while opening, adjusting or closing the awning. Failure to obey this caution could result in injury and/or property damage.

Always operate the awning according to the instructions.

Periodically check that the fasteners are tight (tighten if necessary).

Keep the awning fabric and arms clean.

LEVELING SYSTEM (page 20)

Never use the auto leveling system to lift the RV off the ground. Lifting the RV so the wheels are not touching the ground will create an unstable and unsafe condition.

The leveling system is designed only for leveling the unit and should never be used to provide service for any reason under the RV, such as changing tires or servicing the system. It is not recommended that you change a tire yourself.

Park the RV on level, solid ground.

Ensure all jack locations are clear of debris, obstructions or depressions.

People and pets should be clear of the RV while system is in operation.

Battery should be fully charged or the RV plugged into shore power prior to operating the leveling system.

Keep hands and body parts clear of fluid leaks. Hydraulic fluid leaks may be under high pressure and can cause serious skin-penetrating injuries.

Using the leveling system in a manner other than its intended use will void the limited warranty.

Failure to act in accordance with these warnings may result in serious personal injury or death!

STABILIZERS (page 20)

DO NOT USE THE STABILIZER JACKS TO LEVEL THE RV. It is important to remember that the stabilizer jacks are to be used only for support while occupying and moving around the RV. They are not designed to support the weight of the RV.

The stabilizer jacks must be fully retracted before moving or towing the RV to prevent stabilizer jack damage.



WARNING



VEHICLE OPERATION WARNING Continued

EMERGENCY TOWING (page 22)

Never allow anyone to go under the recreation vehicle while it is being lifted and/or towed.

WHEEL LUGS (page 22)

Check and tighten wheel lug nuts regularly to make sure they did not loosen during travel. Wheel lug nuts must be applied and maintained at the proper torque levels to prevent loose wheels, broken studs, and possible separation of the wheel(s) from your recreation vehicle. The lug nuts on the wheels of your recreation vehicle must be maintained according to listed torque values (see “Wheel Lug Nut Torque Values” on page 22.) Over-torqued and/or under-torqued wheels may result in component failure.

Wheels should ALWAYS be mounted and properly torqued by a qualified service technician using the proper tools.

Failure to maintain proper torque of the wheel lug nuts could lead to separation of the tire and wheel while driving, possibly resulting in property damage or personal injury.

WHEEL LUG NUT TORQUE VALUES (page 22)

Prior to travel and after excessive braking, wheel lug nuts should be checked for torque. Torque readings must fall within the Final Torque Values in the chart “Wheel Lug Nut Torque Values” on page 22.

Torque specifications should be checked using a proper torque wrench.

If the torque falls below the Final Torque Values, additional torque is required.

Check and re-torque lug nuts at 10 miles (16 Km), 25 miles (40 Km) and 50 miles (80 Km) and again periodically during travel. Refer to “WHEEL LUGS” on page 22 for proper lug pattern and Final Torque Values. Thereafter check and maintain torque according to the Final Torque Values in the chart “Wheel Lug Nut Torque Values” on page 22.

Failure to follow these instructions may result in wheel loss, an accident, or loss of control, resulting in death or serious injury.

TIRE PRESSURE (page 23)

It is recommended that the tire pressure be checked at the beginning of each trip to obtain the maximum life of the tire. Follow the instructions listed on the Federal Certification label, to determine the correct tire pressure. Under-inflation may cause tire failures and swaying resulting in loss of control, injury, death or property damage.

Towable recreation vehicles are equipped with special trailer (ST) tires that have a maximum speed rating of 65 MPH (104 km/h). You should not exceed this speed rating. Exceeding the tire speed rating may result in tire failure, which could lead to an accident causing serious injury or death.

EMERGENCY STOPPING (page 22)

For personal safety, always stand off the road and out of the way of traffic.

TIRE PRESSURE MONITOR SYSTEM (page 24)

FAILURE TO ACT IN ACCORDANCE WITH THE FOLLOWING WARNINGS MAY RESULT IN SERIOUS PERSONAL INJURY OR DEATH!

The TPMS system is designed to monitor tire pressure and temperature. It is not designed to provide warning of sudden critical tire damage and blowout caused by external effects. The driver should react promptly to any warning and correct the problem.

Tires can fail for other reasons besides low pressure, high temperature, or overloading. Always be on the alert for other tire problems as indicated by unusual noises, vibrations, uneven tread wear, or bulges on the tires. If any of these symptoms occur, have the tires inspected immediately by a tire professional.

CHANGING A TIRE (page 24)

Do not use the stabilizer jacks to support the recreational vehicle while under the vehicle or changing tires. The stabilizer jacks are designed as a stabilizing system only. Do not use the stabilizer jacks as a jack or in conjunction with a jack.

Never raise the recreational vehicle by placing the jack under the axle, springs or any attachment parts.

When replacing tires:

Be sure to use only tires that are rated for recreation vehicle use. The use of passenger tires should be avoided. The load rating/range embossed on the sidewall of passenger tires must be de-rated accordingly; they do not have the same load capability as tires that are specifically identified for recreational vehicle use. Failure to use tires that are properly matched to your recreational vehicle could lead to premature tire wear or less than optimum trailer handling.

Be sure to replace it with a tire of the same size and specifications (refer to the Federal Certification label.)

Failure to comply with these guidelines could result in damage to the vehicle and risk causing serious injury or death.

SPARE TIRE CARRIER (page 24)

DO NOT exceed the maximum load capacities of 100 lbs. for the hoist. DO NOT use air driven guns or impact wrenches to lift the spare tire to the travel position.



WARNING

VEHICLE OPERATION WARNING Continued

CARGO RAMP DOOR (page 28)

Do not load or unload your RV without first blocking all wheels to prevent trailer movement. Movement during loading or unloading may cause the cargo ramp door to shift and tongue jack to bend.

Do not sleep in the cargo bay area while internal combustion engines are being operated, stored, or transported in the RV.

Do not use the patio deck for any purpose other than the intended use. Doing so will void your warranty.

Failure to comply with any of these warnings may result in personal injury or property damage.

AUTOMATED RAMP DOOR SUPPORT CABLES (page 28)

Rear patio cables **MUST** be detached from the ramp door before trying to close it.

Damage could occur to the ramp door or the locking mechanism if cables are not removed.

PATIO DECK - REAR (page 29) PATIO DECK - SIDE (page 30)

Caution should be taken not to exceed the maximum patio weight capacity and to maintain even weight distribution.

Maximum capacity is 10 people 1500 lbs. (680 Kg) and an evenly distributed load when in the patio position.

Stabilizers or leveling jacks **MUST** be used when the patio is deployed and in use.

Failure to observe the weight limit or use other than intended may result in property damage or serious personal injury.

LOADING THE CARGO AREA (page 29)

These guidelines must be followed when loading the cargo area:

- **DO NOT EXCEED YOUR GVWR!** This means you should weigh your RV as loaded for your normal travel to determine the actual weight. If you exceed the GVWR, you **MUST** remove items from the RV, or drain liquids, then re-weigh the vehicle to ensure you have achieved a safe weight. Do not travel with full grey/black holding tanks. Depending on the location of the grey or black holding tanks, it can affect handling characteristics.
- Do not exceed the maximum weight capacity of the cargo ramp. See "CARGO RAMP DOOR" on page 28.
- Failure to comply with weight capacities and distribution could result in an accident or loss of control resulting in death or serious injury.
- Your recreation vehicle's load capacity is designated by weight, not by volume, so you cannot necessarily use all available space when loading the vehicle. Do not exceed your GVWR and ensure you are loading the vehicle as evenly as you can for the best possible handling. Ensure heavy items are secured so they do not shift during travel.

Failure to comply with weight capacities and distribution could result in property damage or serious injury.

Any motorized vehicle or motorized equipment powered with flammable liquid can cause fire, explosion, or asphyxiation if stored or transported within the recreational vehicle. To reduce the risk of fire, explosion or asphyxiation:

- Do not ride in the vehicle storage area while vehicles are present.
- Do not sleep in the vehicle storage area while vehicles are present.
- Close doors and windows in walls of separation (if installed) while any vehicle is present.
- Run fuel out of engines of stored vehicles after shutting off fuel at the tank.
- Do not store, transport, or dispense fuel inside this vehicle.
- Open the windows, openings, or air ventilation systems provided for venting the transportation area when vehicles are present.
- Do not operate propane appliances, pilot lights, or electrical equipment when vehicles are present.

FAILURE TO COMPLY COULD RESULT IN AN INCREASED RISK OF FIRE, EXPLOSION, OR ASPHYXIATION RESULTING IN DEATH OR SERIOUS INJURY.

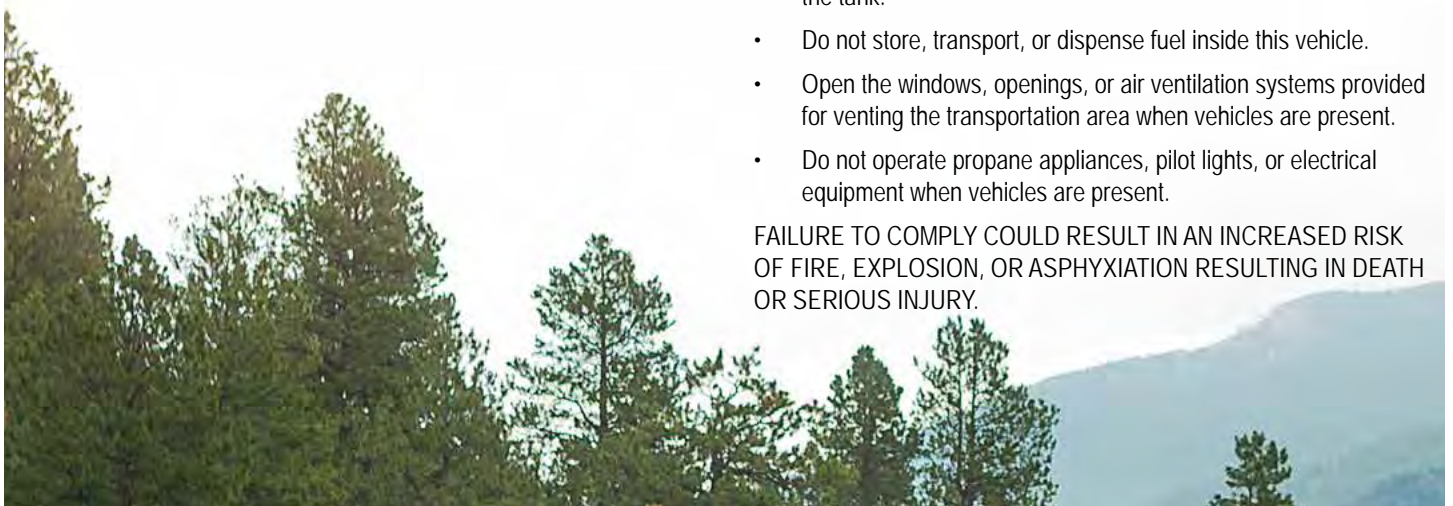

CAUTION

TOWING (page 17)

BEFORE TOWING YOUR RV ON THE ROADWAY: TURN OFF THE DISCONNECT SWITCH!

Certain components inside the RV can unexpectedly activate which could result in personal injury or property damage.

BREAKAWAY SWITCH (page 18)

NEVER use the breakaway switch and trailer brake system as a parking brake. Doing so would create a high amp draw on the battery and converter. This can cause damage to wiring, connectors and the breakaway switch.

ENTRANCE DOOR (page 19)

Make sure the entrance door is completely closed and locked when traveling. Locking the door helps prevent it from opening unintentionally and keeps intruders from your recreation vehicle.

TIRES (page 23)

Tire wear should be checked frequently. Once a wear pattern becomes firmly established in a tire it is difficult to stop, even if the underlying cause is corrected.

AWNINGS (page 31)

The effects of wind and rain on an awning are unpredictable and can cause severe damage to the awning and/or the recreation vehicle.

Retract the awning if:

If wind or extended periods of rain are expected.

If you leave the RV unattended for a length of time, to avoid unexpected climate conditions.

TIRE PRESSURE MONITOR SYSTEM (page 24)

TPMS sensors – DO NOT MOVE WITH THE TIRES!

The TPMS sensor on the front tire (on either side of the trailer) STAYS at the front tire position when rotating tires.

The TPMS sensor on the middle tire (on either side of a 3-axle trailer) STAYS at the middle tire position when rotating tires.

The TPMS sensor on the rear tire (on either side of the trailer) STAYS at the rear tire position when rotating tires (on both dual and triple axle trailers).

This guarantees tire pressures displayed on the touchscreen are accurately showing the correct tire locations on the trailer.

SETTING UP YOUR RECREATION VEHICLE (page 25)

Never use stabilizer jacks to level the RV.

AUTOMATED RAMP DOOR (page 29)

Automated Door: Remove the patio support cables, safety pins and quick links before folding up the ramp door. Failure to do so may damage the ramp door or door mechanism.

SIDE RAIL SETUP (page 29) PATIO DECK - SIDE (page 30)

When returning the cargo door to the stowed position, be sure all safety pins used to secure the side rails during transit are in place and secure with the safety clip in place. Failure to do so could result in damage to the rail and door.

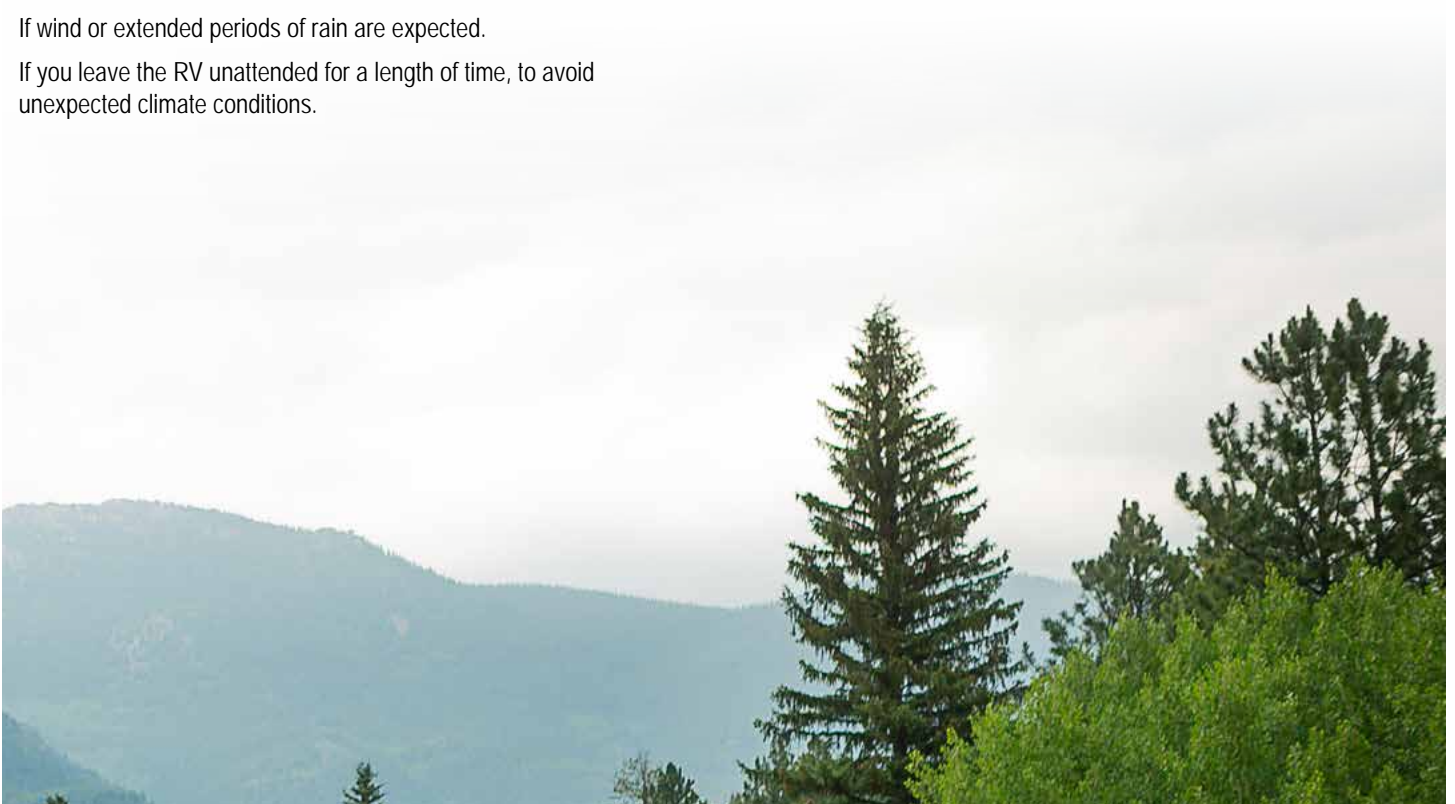

SECTION 5: SLIDEOUT SYSTEMS



ELECTRIC SLIDE ROOM(S) (IF EQUIPPED)

General Slideout Operation

- The auxiliary battery (customer supplied) must be fully charged and connected. If possible, the RV should be hooked up to 120-volt AC power so the converter operates.
- The RV must be level and the stabilizer jacks extended.
- Slideout switches are typically located inside the RV, either in the command center or on the wall.
- **To extend the slideout**, locate the slideout control switch and press OUT/EXTEND; hold until the slideout room stops.
- **To retract the slideout**, press IN/RETRACT on the slideout control switch and hold until the slideout is fully retracted.



Slideout Control Switch Example

Slideouts may also be controlled by the JAYCOMMAND/TraveLINK system (if equipped) through the touch screen interface, mini interface, and/or through the smart phone app.

If the slideout is equipped with rubber seals, verify that the corners of the black rubber seal are set up correctly. The top of the outside seal must overlap the side of the seal to avoid the possibility of water penetration. On the inside seal, the top seal should overlap the sides.

NOTE

For long-term storage it is recommend the slideout be retracted.

WARNING

Make sure the interior slideout room path and the slideout room itself is clear of people and objects before operating.

Keep away from the slide rails and gear assembly when the room is in motion. They may pinch or catch on loose clothing causing personal injury.

Failure to follow these instructions could result in serious injury or death.

CAUTION

These guidelines should be followed when using your slideout room:

- Make sure the slideout is in the closed position prior to hooking the unit to the tow vehicle.
- The recreation vehicle must be level before operating the slideout room. Water leaks and other problems could result if the slideout is operated without leveling the RV.
- Do not place excessive weight in the slideout room. It can cause the slideout room to malfunction and cause damage to the slideout.
- Do not over extend/retract the slide out room. Release the switch immediately once the room has been fully extended/retracted. Over extending/retracting the slide out room may result in damage to the stop rod and bracket.
- Additional support jacks are not needed under the slideout. Damage can occur to your slideout room from improper use of aftermarket support jacks.

General Slideout Troubleshooting

For additional troubleshooting information, refer to the specific slideout system detail on the next page.

If the slideout doesn't move when the slideout switch is pressed:

1. Check the auxiliary battery (customer supplied) for a full charge and good wire connections.
2. Check the 12-volt fuse or circuit breaker.
3. Check for loose connections at the slideout motor.

If the slideout still will not operate:

1. If the slideout is extended, refer to the section for the specific slideout system on the next page, to manually retract it.
2. If the slideout is retracted, leave it in that position.
3. Contact your dealer or customer service for repair assistance.

If the slideout extends crooked or only one side moves:

1. Contact your dealer or customer service for repair assistance.

SLIDEOUT SYSTEMS

Slide Types

Through Frame

Location: Both flush floor & above floor. Will be on the main floor of a 5th wheel, or any travel trailer where the slideout is at the floor level.

Characteristics: Ram arms can be found under the slideout.

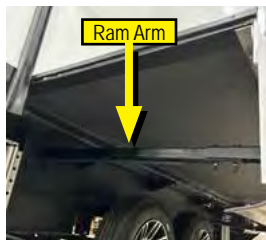

Manual Retract Procedure: On the opposite side of the coach from the slide there will be a 3/4" nut either on the frame rail (A) or on a motor accessed through a removable, screwed-down panel on the under-side (B). Using a ratchet or a tire iron, rotate the nut clockwise to retract the slide manually.

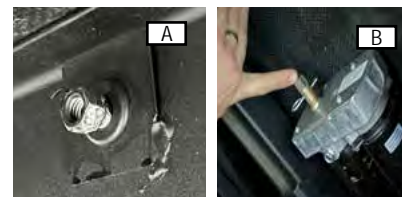

Lippert - Schwintek In Wall

Location: Found throughout the coach whether it's a 5th wheel or travel trailer.

Characteristics: There will be two tracks on each end wall both fastened to the box. One track will be at the very bottom and the other will be toward the top.



Manual Retract Procedure: Locate the slideout system controller (C). Unplug motor 1 and motor 2 connectors at the bottom of the slideout controller. This releases the motor brakes for each motor. The slideout room can now be manually pushed in. Larger rooms may require several people to push or pull them. Keep both sides of the slideout even while pushing/pulling. When the room is completely in, plug both motor connectors back into the control module. This will apply the motor brakes for road travel.



Lippert Slim Rack In Wall

Location: Found throughout the coach, used for main floor slideouts that are larger than 120".

Characteristics: There will be two small/thin tracks on each end wall.



These tracks are only fastened at each end of the track and appear to "float" on the endwalls.

Manual Retract Procedure: Due to the motors being located in the wall and the size of the slide out, the Lippert Slim Rack system will need to be manually retracted by a professional. Please contact Customer Service, or your nearest Jayco Dealer for assistance.

Norco Exact Slide™ In Wall Cable Slide (5.5)

Location: Both flush floor & above floor. Can be throughout the coach on both 5th wheels and travel trailers.

Characteristics: There will be two cables on each endwall, one in both the lower and upper portion of the wall.

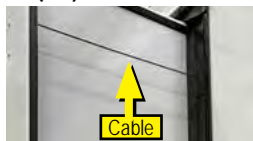

Manual Retract Procedure: The slide-out motors can be accessed behind the corners of the upper fascia on the interior

of the slide. The flexible drill extension (D) provided in your Customer Information Packet is used to manually turn the motors. Retract the motors by rotating clockwise. Retract each side in small steps, going back and forth from side to side, until the slide is full retracted.



Norco Accu Slide™ Traditional Cable Slide (G4)

Location: Both flush floor & above floor: Can be throughout the coach on both 5th wheels (above floor only) and travel trailers (either setup).

Characteristics: The center of the interior fascia on the top of slide room will bow outward and protrude into the coach. Behind the curve in the fascia is the slide-out motor, gears, and cables.

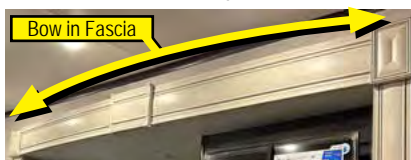

Manual Retract Procedure: You can access the slide out motor from above the fascia; but if there is not enough room above to allow access, the fascia will need to be removed. The top, bottom, center, and end trim pieces are attached to a



View of Slide Motor System Behind Fascia

header board with brad nails. The center trim piece is attached with glue. Gently pry the trim away to reveal screws that attach the header board to the slide-out roof. Remove the screws to take the fascia down. Use the flexible drill extension (D above) provided in your Customer Information Packet to turn the motor clockwise and retract the slide-out.



Motor Access Point

NOTE

Fascias that do not have center and end trim pieces, need only remove the bottom trim to access the header board screws.

SECTION 6: ELECTRICAL



THE ELECTRICAL SYSTEM

The RV electrical system is comprised of two independent electrical systems. One operates off of 12-volt DC power and the other off of 120-volt 60hz AC power. All installations have been made in compliance with industry standards applicable on the date of manufacture. Because the electrical equipment and associated circuitry are engineered into a dedicated system specific to your RV, do not make unauthorized changes or add fixed appliances to it. Changes or additions made after delivery may result in a hazardous condition.

Service and/or modification of the electrical system should only be performed by qualified electrical technicians using approved materials, components, and methods meeting current safety and code requirements. Consult your dealer's service department for assistance.

To read more about the various components incorporated into the RV electrical system, please refer to the information contained in your Customer Information Packet.

Electrical System Maintenance

⚠ WARNING ⚠ (See page 53)

Before working on the electrical system:

- Make sure the inverter/charger (if equipped) is turned "off" before disconnecting batteries.
- Disconnect the shore power cord.
- If equipped with a generator, turn off the generator and disable the automatic generator start functionality.
- Turn off the disconnect switch (if equipped).
- Turn off the 120-volt main circuit breaker.
- Disconnect the negative battery terminal from the battery.

12-VOLT DC SYSTEM

The majority of RV lighting is powered by 12-volt electricity. The 12-volt DC system will operate when the following conditions are met:

- Power is supplied by the tow vehicle alternator when the engine is running and the 7-way trailer plug is connected. This powers the RV's running lights, brake lights, turn signals and brakes. In addition, the 7-way trailer plug provides a common ground and a 12-volt charge line to charge the auxiliary battery.
- The converter will supply interior 12-volt DC power when the power cord is plugged into campground power. The converter will also charge the RV battery in most situations.
- The auxiliary battery powers many interior 12-volt components including the lighting fixtures, water pump, 12-volt motors, 12-volt appliances, etc. It also powers the breakaway switch.

12-Volt Fuse Panel

⚠ WARNING ⚠ (See page 53)

The 12-volt fuse panel is labeled to indicate fuse sizes, positions and the components powered. Fuses are located in the load center.

Replacing a fuse

Before replacing a fuse, always turn off the electrical components protected by it.

1. Disconnect the shore power cord.
2. Turn "off" the inverter (if equipped).
3. Disconnect the negative battery terminal from the battery.
4. Remove the fuse panel cover to check fuses.
5. Pull the fuse straight out of the fuse block.
6. Insert a new fuse of the same specified voltage, amperage rating and type in the original location.



12-Volt DC/USB Outlet

⚠ WARNING ⚠ (See page 53)

There may be one or more 12-volt DC/USB power outlets in your recreation vehicle. When these outlets are used as a power source for an electric appliance make sure the appliance operates on 12-volt DC power and that it consumes less than 60 watts (5 amps) of power.

**LOAD CENTER**

The Load Center contains 12-volt DC fuses and 120-volt AC circuit breakers for almost all of the electrical appliances and circuits in the RV. The 120-volt main breaker may be located in this panel and will turn off all 120-volt power to the RV. Load center location, appearance and configuration may vary by model. Refer to the diagram inside the load center for specific fuse assignments.

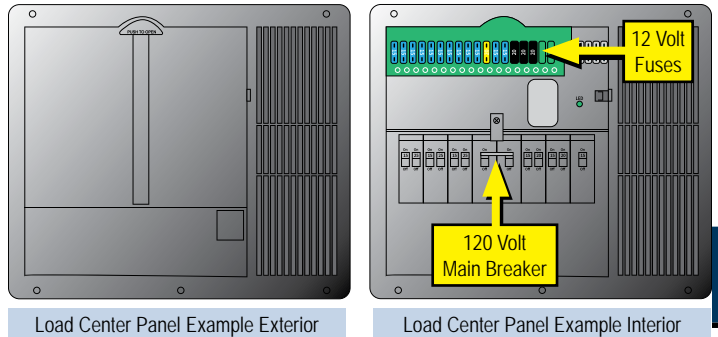

Load Center Panel Example Exterior

Load Center Panel Example Interior

Some models may have separate small panels for breakers and fuses. They are normally located in close proximity to each other typically in the bed platform. The converter is mounted separately, typically under the bed platform.

EXTERIOR LIGHTS (IF EQUIPPED)

Your recreation vehicle may be equipped with one or more of the following exterior lights.

- **Utility Light:** the utility light is mounted under the front cap. The on/off switch is mounted on the light.
- **Security Lights:** There may be up to (3) security lights mounted on either side of the unit. Switches to operate these lights are typically located in the control center.
- **Fifth Wheel Docking Lights (if equipped):** Your RV may be equipped with (2) docking lights on the front cap. A switch located next to the fifth wheel hitch under the front cap controls these lights.
- **LED Front Cap Strip Lights:** The switch for the front cap LED strip lights may be located inside a compartment near the front of the RV, on the exterior wall near the front, or next to the fifth wheel hitch (if applicable).
- **LED Awning Lights:** Your model may be equipped with LED strip lights installed under each side awning. The controls for the awning lights are located in the interior command center. Typically the switch for the rear side awning lights is in the cargo bay area (if equipped).
- **Ramp Lights:** The control for the ramp lights (above the rear door - if equipped) is located either in the command center or in the cargo bay area.

REPLACING LIGHTING

Replacement lighting must be the same type, voltage and wattage listed on the lamp fixture. Use of incorrectly sized replacements can overload lamp circuits and may create a fire hazard by overheating the fixture.

ELECTRICAL

COMMAND CENTER

The command center is typically located inside the entrance door or in the living area of the RV, and contains switches and controls. Command center applications, configurations and components may vary by model.

Command Center Panel or Command Center Panel with Switch Modules

Items found on these panels may include:

- Fuel gauge and hour meter with switches for fuel pump and fuel levels; fuel station (if equipped) on/off switch
- Lighted red pump and water heater switches (electric and LP gas)
- Generator start / stop switch; may include hour meter
- Tank heater switches
- Light switches for porch lights, exterior security lights, interior lights, awning LED lights, front cap LED accent lights, power entry step
- Cargo bed red lighted control switch
- Slideout control switches (press and hold to extend / retract)
- Awning control switches (press and hold to extend / retract)
- Systems monitor with LED indicators for tank levels and battery charge status
- Auto leveling control panel (for leveling the RV)
- Inverter panel (power switch with display)
- Power bunk bed lift control switch
- Speaker selector switch
- DSI water heater fault light

Fault/DSI Fault Light

The DSI (Direct Spark Ignition) Fault Light will illuminate if the gas water heater burner will not ignite. For additional information, see "Gas/Electric DSI Tank Water Heater System (if equipped)" on page 68.

Touch Dimmer Switch

Some models may include a touch dimmer switch next to the Command Center panel.

- Turn the ceiling lights ON or OFF: Tap the LED light on the dimmer.
- Dimmer: If lights are off, press on the LED light and lights will begin turning on gradually until fully lit. If lights are on, press on the LED light and lights gradually begin to turn off.

The dimmer has a memory and retains the light setting last used. When turned ON again, the lights revert to that setting.



Command Center Examples

GFCI RECEPTACLE

There is a ground fault current interrupter (GFCI) engineered into the electrical system. It is designed to reduce the possible injury caused by electric shock. The GFCI will not protect against short circuits or circuit overloads.

Test all GFCI receptacles monthly.

- Push in the "TEST" button. The "RESET" button should pop out indicating the GFCI receptacle has been tripped and interrupted 120-volt power.
- Push in the "RESET" button to restore 120-volt power.

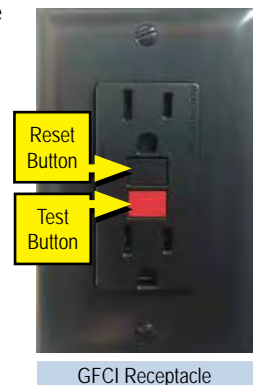

GFCI Receptacle

Contact your dealer for assistance if the "RESET" button does not restore 120-volt power and pops back out.

NOTE

A "tripped" GFCI breaker indicates that abnormally high 120-volt current flow (a ground fault) was detected. All ground faults must be repaired before use of the recreation vehicle.

JAYCOMMAND®/TRAVELINK® SYSTEM (IF EQUIPPED)

The JAYCOMMAND/TravelINK touchscreen is a wall-mounted control giving you freedom to operate multiple RV functions from one location inside the RV.



Refer to the JAYCOMMAND/TravelINK by BMPRO user guide for complete operating, setup and programming instructions.

A digital version of the operator manual may be included with the system. On the HOME screen (upper right corner) press the SETTINGS button (the small Gear icon) and scroll the screen down until you see "USER MANUAL". Tap to open.

The complete BMPRO user guide is also available from within the JAYCOMMAND/TravelINK App.

The touchscreen and remotes connect to the smart RV system node via Bluetooth. The JAYCOMMAND/TravelINK Controller (touchscreen) has Wi-Fi capabilities to connect to the internet to download the latest app updates. The system has a downloadable app available for your smartphone, tablet or smart device.

The following list describes some of the features the smart RV system may control. Depending on your model or system, not all of these features will be available.

- Fresh, black, and gray water tank levels
- Power jacks, stabilizers, and auto leveling systems
- Gas and electric water heaters
- Interior and exterior lights
- HVAC thermostat
- Slide-out rooms and power awnings
- Solar controller
- Battery levels
- Water pump
- Generator
- Inverter



Touchscreen Control Panel

The row of buttons at the bottom of the touchscreen control certain pre-programmed features, the slideouts, awnings, lights and water pump. In the event the touchscreen is not working, this button row will allow manual operation separate from the touchscreen.

NOTE

Buttons #1 through #4 are pre-programmed from the factory and cannot be changed to perform other functions.

- **Button #1** – Turns all interior lights ON or OFF. Press once for ON, press again for OFF.
- **Button #2** – Turns all outside lights ON or OFF, which include security lights, awning lights, and ramp door lights (toy hauler). It does not operate the front cap LED lights. Press once for ON, press again for OFF.
- **Button #3** – Turns inside and outside lights ON or OFF. Press once for ON, press again for OFF.
- **Button #4** – Turns water pump ON or OFF.
- **Arrow Buttons** – Use to select awnings or slideouts, pair your smart phone or tablet to the touchscreen system, pairing the dedicated remotes, or to turn the touchscreen display OFF.
- **RESET Button** - There is a small pinhole above the left arrow on the Menu Display that will reset the touchscreen.
- **EXT Button** – Use in conjunction with the arrow buttons to extend an awning or slideout.



ELECTRICAL

- **RET Button** – Use to Retract either slideouts or awnings. Use in conjunction with the arrow buttons to select an awning or slideout (also used when pairing wall mounted remotes to the system).

Menu Display (between arrow buttons) use the arrow keys to scroll through the selections.

- Menu Display shows **A1** or **A2** (awnings). Cycle between awnings with the arrows. Press and hold **EXT** or **RET** to extend or retract the selected awning.
- Menu Display shows **S1, S2, S3** or **S4** (slideouts). Cycle between slides using the arrow buttons. Press and hold **EXT** or **RET** to extend or retract the selected slideout.
- Menu Display shows **OF** (OFF). Pressing the **EXT** button turns off all lights, fans, and the touchscreen). This does not shut down the generator. Press any of the numbered light buttons to turn the touchscreen back on.
- Menu Display shows **PA** (pair). Press **EXT** to pair your phone or tablet or press **RET** to pair one of the wall mounted remote controls. The **PA** on the small display will flash on and off indicating the system is in pairing mode and can be connected to a Bluetooth smart device. When the device is paired, **PA** display will go out.

Pairing a Smart Device to the JAYCOMMAND/TravelINK App

Download and install the JAYCOMMAND/TravelINK app from the Google Play or Apple App Store. Follow the instructions in the app to connect to the system. Up to (3) personal Bluetooth devices can be connected to the JAYCOMMAND/TravelINK system at the same time.

NOTE

The JAYCOMMAND/TravelINK "Motors" screen automatically locks on your smart device after connecting to the app to prevent inadvertent operation of the systems in the RV. The lockout indicator on the screen must be swiped to unlock the motor controls. When operating any motor control, the system locks out all other control devices (e.g. smartphone or command panel) until the motorized device in use has stopped.

Heating/Cooling operation

There are no thermostats located in the RV. Heating and cooling is controlled through the BMPRO JAYCOMMAND/TravelINK touchscreen Climate screen. One or more small sensors are located on the walls of the RV. These sensors work with the touchscreen to monitor the temperature in an area of the RV and adjust according to climate settings on the touchscreen.

Home Screen

Shows an overview of the key features of your RV: climate, lights, motors, tanks and energy.

Water Screen

Shows tank monitors (black, gray, fresh) water pump switch, water heater switches for gas and electric and possibly the tank heater switch.

Motors Screen

Shows controls for the leveling system, awnings, slideouts, jacks and the ramp door (if applicable).

- The app on your smart device automatically locks out the Motors screen on your device. You must swipe to unlock the screen in order to operate motors.
- Only one motor may be operated at a time.
- When a motor is in operation, motor control is disabled on any other device running the JAYCOMMAND/TravelINK app.

Climate Screen

Shows the thermostat to control heating and cooling and fan speed.

Lights Screen

Turn lights on and off as well as dim certain lighting with sliders.

Energy Center Screen

Shows generator on/off, AGS (auto generator start), battery levels, Inverter on/off, solar data, and fuel levels.

Fans and Vents Screen

Shows kitchen and bath fans and automatic vents (if equipped). Turn fans on and off, and open and close automatic vents.

System Switches (remote controls)

The system will come with multiple individual smart remote controls installed on the wall in each room.

The smart RV system remote controls use a 3-volt Lithium CR2032 coin cell battery.

To access the battery on the back of the remote, remove the remote from the wall:

1. Pull the bottom of the remote away from the wall. There will be an audible snap as it releases from the clip.
2. Lift the remote upwards to unhook it at the top.
3. The remote will separate from the wall mount.

To replace the remote on the wall:

1. Hook the top of the remote on the top of the wall bracket.
2. Push the bottom of the remote back in place. There will be an audible snap as it attaches to the mount.



Tire Pressure Monitor System (TPMS)

⚠ WARNING ⚠ **⚠ CAUTION ⚠** (See page 54)

Depending on your model, you may have a Tire Pressure Monitor System (TPMS). The TPMS system is monitored by sensors paired to the system through the touchscreen. The TPMS System comes with sensors that screw on to the valve stem either inside or on the outside of each tire. The sensors are programmed according to their tire position on the trailer, and not to each individual tire.



External TPMS Sensor

Quickstart Guide

For your convenience a quickstart guide is available from within the JayCommand/TravelINK mobile phone app that walks you through the steps to setup your RV at the campsite or prepare it for travel.

BM PRO MINI SYSTEM (IF EQUIPPED)

The JAYCOMMAND/TravelINK BM PRO Mini is a control panel used to monitor and control various systems in your RV.

Refer to the manufacturer's user guide for detailed operating information.

The system has (3) parts: the NODE, the DISPLAY and the JAYCOMMAND/TravelINK Smartphone App. The mini control panel and the Smartphone App connect to the NODE via Bluetooth. The JAYCOMMAND/TravelINK App is available for download for iPhone or Android devices through the Google Play or Apple App Store. Some functions may only be available in the app: TPMS, Solar, Inverter, etc.

The JAYCOMMAND/TravelINK Mini has Wi-Fi capabilities to connect to the internet to download the latest app updates.

The following list describes some of the many features this system may control. Available functions will vary depending on you model. Some functions will not be installed or may not be available for you model.

- RV Auto Leveling System
- Power Jacks and Stabilizers
- Interior and Exterior Lighting
- RV Slideout Rooms
- Power Awnings
- HVAC Thermostat
- Gas and Electric Water Heaters
- Water Tank Level
- Water Pump
- Generator
- Solar
- Inverter

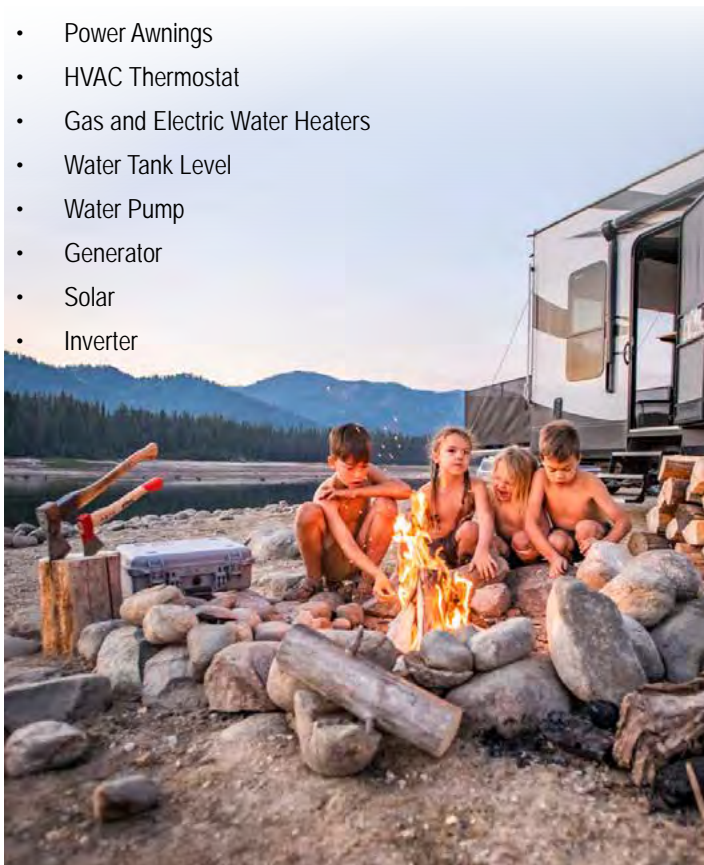

Display Control Screen

The following buttons can be found on the display control unit mounted inside the RV.



Button 1: Page Navigation button allows you to move from page to page (e.g. Tanks page to Water page).

Button 2: Menu Navigation button allows navigation between items within a page. (e.g. in the Water page move from Pump to Elec Water Heater).

Buttons 3 & 4 Action Buttons change functions depending on the selected menu item. These functions will be displayed on the screen (e.g. OK, RET, EXT).

Buttons 5: Redundancy Buttons across the bottom of the display turn on lights, water pumps, and main A/C.

- ◇ First button turns on/off all interior lights (long press sets intensity to 100%).
- ◇ Second button turns on/off all exterior lights.
- ◇ Third button turns on/off all interior and exterior lights.
- ◇ Fourth button turns on/off the water pump.
- ◇ Fifth button brings up the A/C control screen on the display.

Pairing your device

To operate the system with your smartphone, you must download the JAYCOMMAND/TravelINK App. The NODE can be paired to a maximum of (4) devices. Follow the instructions in the app to pair to system.

Display Screens

There are (6) screens (or pages) that are available on the display screen:

- **Tanks page** displays levels of fresh, black, and gray tanks. All tanks will appear regardless of whether all are installed.
- **Water page** shows the water pump, water heater elec. and water heater gas.
- **Motors page** shows all of the slideouts and awnings.
- **HVAC page** operates the AC temperature in the RV.
- **Energy page** shows the generator controls.
- **Settings page** shows pairing, temperature units, software version, forget all (disconnects paired devices).

JAYVOICE / DIRECTOR (IF EQUIPPED)

JayVoice/Director works in conjunction with the existing JAYCOMMAND/TravellINK system to control functions like A/Cs, lights, furnaces, and more. The system is prompted by a wake word, "Jayco" (or "Director" in the case of TravelLink). Once the word is spoken, the voice receiver on the ceiling will light up to indicate that it is listening for a command. Simply say "Jayco" and any of the predetermined commands like "Main A/C", and you can operate a variety of systems with just a few words. The voice receiver is mounted centrally within the RV to allow for utilization in not only the living area, but other rooms throughout the unit.



Ceiling Mounted Voice Receiver

Command	Action
"Wake Word* - All Lights"	Turns on/off all interior [†] & exterior lights
"Wake Word* - Interior Lights"	Turns on/off all interior lights [†]
"Wake Word* - Exterior Lights"	Turns on/off all exterior lights
"Wake Word* - Bedroom Lights"	Turns on/off all bedroom lights
"Wake Word*-Living Room Lights"	Turns on/off all living room lights
"Wake Word* - Dinette Lights"	Turns on/off the dinette lights
"Wake Word* - Kitchen Lights"	Turns on/off the kitchen lights
"Wake Word* - Main A/C"	Turns on/off the main A/C
"Wake Word* - Second A/C"	Turns on/off the second A/C
"Wake Word* - Third A/C"	Turns on/off the third A/C
"Wake Word* - Furnace"	Turns on/off the furnace
"Wake Word* - Movie Mode"	Sets dimmable interior lights to 50% bright. All other interior lights [†] to off
"Wake Word* - Night Mode"	Sets dimmable interior lights to lowest setting. All other interior lights [†] to off
"Wake Word* - Special Mode 1"	Sets all interior lights [†] to full bright
"Wake Word* - Special Mode 2"	Sets master bedroom ceiling lights at 50% bright. Turns off all other interior lights [†]

*Use "Jayco" with JayCommand or "Director" for TravelLink systems.

[†]For lights managed by the JAYCOMMAND/TravellINK system.

NOTE

You can daisy chain multiple commands by saying them one after the other after saying the wake word.

Example: Saying, "Jayco - Dinette Lights, Kitchen Lights, Main A/C", will enact all three commands.



120-VOLT AC ELECTRIC SYSTEM

The following electrical components will only operate when connected to 120-volt power: air conditioner(s), refrigerator, microwave oven, television(s), home theater system(s), water heater, washer, dryer, fireplace, electric stove, and appliances plugged into convenience receptacles. These components will create a surge on the inverter.

A circuit breaker "trip" may occur if you overload the recreation vehicle and/or campground electrical system. Operating appliances collectively places an added load on your 120-volt electrical system. The amperage rating of individual appliances can be calculated by dividing appliance wattage consumed (normally listed on the appliance) by nominal design voltage (120 for a 120-volt appliance). For example: 1200 watts divided by 120-volts equals 10 amps.

120-VOLT 30-AMP AC ELECTRIC SYSTEM (IF EQUIPPED)

⚠ WARNING ⚠ (See page 53)

The 30-amp 120-volt 60hz AC electrical system is designed to operate on 1 leg of 120-volt power at a maximum current flow of 30-amps.

Exposure to voltages higher or lower than a nominal 120-volts will damage or shorten the service life of the electrical system and appliances. The 30-amp 120-volt 60hz AC electrical system can be powered by the 120-volt 60hz utilities found in campgrounds or by 120-volt 60hz generator power.



30 Amp Receptacle

30-amp Power Cord

⚠ WARNING ⚠ (See page 53)

The 30-amp external utility power cord is commonly referred to as the "shore" power cord. It is designed to mate and properly function with 30-amp "shore" power receptacles available at most campgrounds.

The shore power cord is designed to continuously carry the 30-amp current flow required to power each leg of the electrical system. It also creates a critical ground connection between the vehicle electrical system and the campground shore power receptacle.

Calculating 30-amp Electrical Load

When connecting appliances to the electrical system, 120-volt power usage is limited to a total of 30 amps.

120-VOLT 50 AMP AC ELECTRIC SYSTEM (IF EQUIPPED)

⚠ WARNING ⚠ (See page 53)

The 50 amp 120-volt 60hz AC electrical system can be powered by an outside 120/240-volt 60hz utility service like those commonly found in campgrounds or by 120/240-volt 60hz generator power. The entire system is designed to operate on 2 legs of 120-volt power at a maximum current flow of 50 amps per leg.

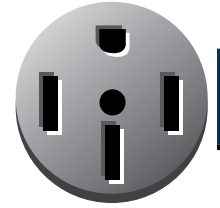

50 Amp Receptacle

Exposure to voltages higher or lower than a nominal 120-volts will damage or shorten the service life of the electrical system and appliances.

50-amp Power Cord

⚠ WARNING ⚠ (See page 53)

The 50-amp external utility power cord is commonly referred to as the "shore" power cord. It is designed to mate and properly function with 50-amp "shore" power receptacles available at most campgrounds.

The shore power cord is designed to continuously carry the 50-amp current flow required to power each leg of the electrical system. It also creates a critical ground connection between the vehicle electrical system and the campground shore power receptacle.

Calculating 50-amp Electrical Load

When connecting appliances to the electrical system, 120-volt power usage is limited to 50 amps per electrical system leg for a total of 100 amps.

TESTING CAMPSITE POWER CONNECTION

⚠ WARNING ⚠ (See page 53)

The campsite 120-volt power receptacle(s) should always be tested for proper functionality prior to plugging in the recreation vehicle shore power cord. Campsite 120-volt power receptacles can be tested using a digital multimeter or a dedicated circuit analyzer. Dedicated circuit analyzers plug directly into the campsite power receptacle and minimally test for open neutral, open ground, and correct polarity. If the ground monitor indicates 'reverse polarity' or an 'open ground' **DO NOT** connect the power cord.

Inspect RV power cords for cuts, cracks and worn insulation. Have the power cord replaced immediately if these symptoms are noticed.



ELECTRICAL

CONNECTING POWER CORD(S)

To help prevent power surges from damaging the connected loads, please follow these instructions when hooking up to the external power source:

1. Turn off the load center main 120-volt circuit breaker and turn off the breaker at the external power source if available.
2. Align the pins on the plug to the RV power connector, and then plug the RV end of the power cord into the RV power connector fully.
3. Rotate the power cord end locking mechanism clockwise by hand until the rotation stops (A). Do not over-tighten.
4. Extend the entire length of the power cord from the electric connector on the RV to the external power source.
5. Fully plug the power cord into the appropriate (30-amp or 50-amp) receptacle at the power source. Be sure all the power cord prongs are correctly aligned into the receptacle.
6. Turn on the load center main circuit breaker in the RV and the breaker at the external power source.

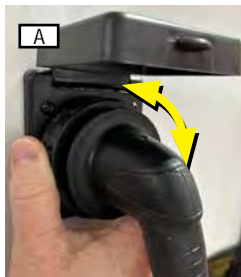

When you are ready to leave, reverse the power cord connection process. Grasp the plug to remove the power cord from the outlet; do not unplug it by pulling on the cord.

POWERED CORD REEL (IF EQUIPPED)

If your recreation vehicle is equipped with a powered cord reel, you can extend or retract the shore power cord using the extend/retract switch located in the same compartment near the cord reel. After extending the shore power cord, connect the cord to the campground shore power receptacle as noted above.

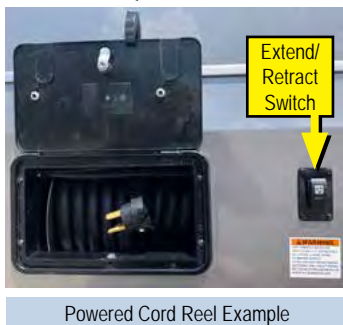

Refer to and follow all safety information found in the manufacturer's product manual included with your Customer Information Packet.

INVERTER (IF EQUIPPED)

A factory installed inverter converts 12-volts DC to usable 120-volts AC and supplies continuous AC power to the appliance plugged into it. It is important that you familiarize yourself with the inverter function and operation. The inverter should be "off" when not in use.

NOTE

The factory installed inverter is not intended for use, nor should be used, with any medical device(s). The inverter may, however, be used with some CPAP machines, depending on the CPAP model. Consult your CPAP machine's instruction manual before use.

If your recreation vehicle is equipped with a residential style refrigerator, the inverter may be used to supply the 120-volts AC necessary to power the refrigerator.

Maintenance

There are no customer serviceable parts inside the inverter case and the manufacturer's warranty will be void if the case has been removed. The inverter cooling fins and the cooling fan should be kept clear of any obstructions.

Command Center Switch (if equipped)

Your RV may have an inverter remote display on the Command Center switch panel. There are power and select buttons, Status/Display indicators, and a single line digital alpha-numeric display. The display can show measured battery voltage, AC output power, inverter settings and error codes.

POWER button is used to turn the inverter on and off. To turn on the inverter and the LED display press and hold **POWER** for 1 second until you hear a beep.

NOTE

When in **Inverter Mode** you will be able to cycle through Battery Voltage, Inverter Power, inverter settings and error codes.

When in **Bypass Mode** you will be able to cycle through Battery Voltage, inverter settings and error codes. Inverter Power will not be available because the inverter is idle.

The **STATUS** and **DISPLAY** indicators indicate the inverter status:

- STATUS & DISPLAY LEDS - both GREEN - Unit is plugged into shore power. The panel is in **Bypass Mode** and will display battery voltage in DC volts.
- STATUS LED AMBER, DISPLAY LED GREEN - **Inverter Mode** is active. Inverter is ON and will display battery voltage in DC volts (not connected to shore power).
- STATUS & DISPLAY LEDS - both AMBER - **Inverter Mode** is active. Inverter is ON, pressing the SELECT button will display inverter power output. Display shows power output in KW.
- STATUS LED FLASHES AMBER, DISPLAY LED IS OFF - If the unit is in **Inverter Mode**, and you plug in shore power, the STATUS LED will begin flashing AMBER and the unit will switch to **Bypass Mode** within 20 seconds of detecting an AC input.
- If the STATUS LED is RED and DISPLAY LED is OFF, the display will show an error code of E01 through E12. This indicates a fault in the inverter circuit that needs attention. Inverter will shut down.

NOTE

The power button is NOT a power disconnect switch and will not remove DC power from the inverter. Disconnect ALL power from the inverter before working on it.

Refer to the Inverter manufacturers' manual in your Customer Information Packet for further operating instructions, error codes, changing inverter settings and safety information.

POWER CONVERTER

CAUTION (See page 54)

The power converter converts 120-volt AC power to usable 12-volt DC power when the shore power cord is connected to an external power source.

The converter has a built-in protective thermal breaker that will shut it down should overheating occur. Overheating can be caused by operating the converter above its maximum power output for an extended period of time, or by an obstruction to its ventilation air flow. To reduce converter heat buildup keep unnecessary 12-volt lights and motors turned off. Keep the converters cooling fins and fan clear of obstructions.

- **USE ONLY A DEEP CYCLE BATTERY FOR RV USE.** Car batteries (CCA rating) are not designed for RV applications.
- If using multiple batteries they must be the same brand and type. Adding more batteries will provide longer use of DC appliances when not on shore power but may reduce charging efficiency.
- The battery works in conjunction with the converter to supply DC power to the RV. A battery is typically only necessary if you do a lot of dry camping or have slideouts and/or a leveling system.
- Reverse polarity fuse provides protection for the converter when a battery is used. If the battery is connected backwards to the fuse board this fuse will blow preventing converter damage.
- Dimming or flickering lights usually indicates an overloaded converter. Remove some of the load by turning off DC lights or appliances.
- Fan is controlled by load. It will begin running at 3 to 6 amp DC draw. It increases in speed with a higher load until 14 to 15 amps. Fan is at maximum speed and stays there even with more load. If load drops below 6 amps DC, the fan shuts off.

Before checking for converter output voltage, the battery cables must be disconnected at the battery. Make sure the converter is plugged into an AC source (105-132 volts AC). Check the converter output voltage at the battery with a voltmeter. Place the voltmeter probes on the disconnected battery cables. If the voltage reads 13.6-volt DC with no load, the converter is functioning properly.

If the converter output voltage at the battery reads in the 0.0-volt DC range, or the battery is not charging, check for:

- An open inline fuse in the battery wire
- An open wire between the converter and the RV battery
- Loose ground connection
- Improper torques

If the converter fuses and AC voltage are good, but the converter output still reads zero volts, the converter is not functioning properly.

Modes of Operation

Absorption (Normal) Mode: 13.6-volt DC range. Batteries are being charged at a slower rate. Converter will not work without AC input.

Float Trickle Mode: To get your converter into this mode, reduce the load on the system to almost nothing but the battery. Let the system sit for approximately 44 hours.

Converter voltage will drop to 13.2-volt DC. If the converter sees any load during this period or after it is in Float Mode it will revert back to Absorption (Normal) Mode. 13.6-volt DC.

Bulk Mode: Converter will not jump into the Bulk Mode unless the battery is below 50% of charge, or approximately below 13.2-volt DC output voltage. There is no way to force it to go into Bulk Mode.

Red LED indicates blown fuse.

Inspection and maintenance

If the 12-volt power converter is not working (auxiliary battery not being charged) check the reverse polarity fuse(s) located on the end of the converter.

There are no customer serviceable parts inside the converter case and the manufacturer's warranty will be void if the case has been removed. If you have further concerns contact your dealer.

For detailed safety and operating information, refer to the manufacturer's owner's manual.

Converter with Charge Wizard (if equipped)

Some converters may be equipped with a charge wizard

There are (3) possible charging modes; NORMAL, BOOST and STORAGE. The charge wizard will automatically select the best mode to charge your battery. A green LED next to the wizard mode button will indicate, by flashes, which mode is currently being used.

Normal Mode: Green LED flashes once per second; battery is between 50% and 90% charged. Green LED flashes 2-3 times per second; battery is 90% charged. Output voltage is 13.6-volt DC and the converter is safely completing the charge of the battery.

Boost Mode: Green LED is on solid. Output voltage is 14.4-volt DC to rapidly charge the battery up to 90% of full charge.

Storage Mode: Green LED flashes every 6-8 seconds. Output voltage has been reduced to 13.2-volt

DC; the RV battery is fully charged and converter is maintaining the charge.

Manual Mode (not recommended):

The manual mode button is used to override the charge wizard. Refer to the converter owner's manual for additional information.

Reverse Battery

Protection: Reverse polarity fuse(s) provide protection for the converter when a battery is used. If the battery is connected

backwards to the fuse board a fuse will blow preventing damage to the converter. Four easily accessible fuses are located next to the wizard button. Replace with fuses of the same type and rating.

LI/LA Switch: Sets the charge mode for Lithium (LI) or Liquid Acid (LA) batteries. Contact your dealer or customer service for more information before changing this setting.

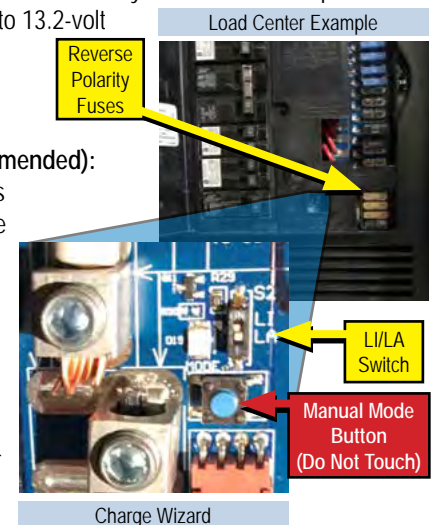

ELECTRICAL

120-VOLT CIRCUIT BREAKERS

⚠ WARNING ⚠ **⚠ CAUTION ⚠** (See page 54)

The 120-volt AC circuit breakers located inside the load center protect all 120-volt wiring and components from circuit overloads and short circuits. Should a circuit overload or short circuit occur the circuit breaker protecting the affected circuit will “trip” preventing the flow of electricity through that circuit.

If a circuit breaker trips, shut off the appliance on that circuit (i.e., power converter, etc.) and allow the circuit breaker to cool down for a brief period of time. After it cools down, reset the circuit breaker by moving its lever “off” and then back to the “on” position. If the circuit breaker re-trips or frequently trips, contact your dealer to have the electrical problem diagnosed and repaired.

Please contact your dealer for repair assistance when replacing circuit breakers.

Maintenance

At the beginning of the camping season, inspect the circuit breakers and replace as needed. Test by turning each circuit breaker “off” and back “on”. Circuit breakers are wearable parts and must be replaced as needed as part of your RV maintenance. If you have any questions, contact your dealer.

A label is provided to explain the function of every 120-volt circuit breaker. This label is located on or near the appropriate load center or sub-panel and must remain permanently affixed to the recreation vehicle.



APPROXIMATE ELECTRICAL LOAD RATINGS

12-VOLT SYSTEM	
Exterior Entertainment Center	5-7 amps
Fan	1.5 amps
Furnace	12.0 amps
Generator Start	95.0 amps*
Illuminated Switch	.125 amp
Inverter	Variable
Leveling System	95.0 amps*
LP Detector	.125 amp
Light; LED	1.7 amps
Light; Vanity	4.2 amps
Lights; Aisle	1.0 amp
Lights; Baggage Compartment / Shower	1.4 amps
Lights; Decorative Wall / Map / Porch	1.5 amps
Lights; Double -12"	2.0 amps
Lights; Double -18"	2.5 amps
Power Awning	10.0 amps*
Power Vent	5.0 amps
Refrigerator	3.0 amps
Step Cover	10.0 amps*
TV Plate/Antenna Booster	1.0 amp
Water Heater	6.0 amps
Water Pump	7.0 amps

*Momentary Load

12-volts: Labeled watts divided by 12 = Power consumed in amps

120-VOLT SYSTEM	
Air Conditioner	18 amps
Coffee Maker	6-12 amps
Converter (each)	8 amps
DVD System	3 amps
Fireplace	15 amps
Hair Dryer or Curling Iron	10-14 amps
Microwave	15 amps
Refrigerator	6 amps
Satellite Receiver	2 amps
TV	2-4 amps
Vacuum Cleaner	8 amps
Washer/Dryer	12 amps
Water Heater	12 amps

120-volts: Labeled watts divided by 120 = Power consumed in amps

AUXILIARY BATTERY (CUSTOMER SUPPLIED)

⚠ WARNING ⚠ (See page 53)

The combined 12-volt DC loads in your recreation vehicle can become more than the power converter is able to produce. This demand can be met by using an auxiliary battery for a limited period of time. The 12-volt system is designed for usage with a Group 27 or 31, deep cycle battery. If the RV came with a solar package installed, then the unit may have been equipped with a lithium battery for this purpose. For info, see "SOLAR PACKAGE (IF EQUIPPED)" on page 52.

NOTE

A charged auxiliary battery must be installed before the RV is towed. The auxiliary battery powers the emergency braking system used to automatically activate trailer brakes in the event the trailer becomes disconnected from the tow vehicle.

Dry Camping

The auxiliary battery should be fully charged prior to dry camping. If the auxiliary battery is not being recharged and power is being drawn from it, it will eventually discharge. Plan your electrical usage accordingly. You can test the auxiliary battery voltage using a volt-ohm meter (customer supplied).

A fully charged lead acid or AGM auxiliary battery will read 12.7-volts DC and 1.265 specific gravity at 80°F (32°C). The auxiliary battery is considered discharged at 10.89-volts, and dead at 10.65-volts. If the voltage drops below those levels, irreversible damage can occur. Typically, a deep cycle battery has an amp-hour rating of 75-100 amps.

If you run the furnace and refrigerator simultaneously, you will be using approximately (12.0 + 3.0) 15.0 amps per hour. This does not include any 12-volt lights, or any other 12-volt component. If the furnace and refrigerator in this example operated constantly, a 75 amp-hour battery would become fully discharged in 5 hours.

The auxiliary battery should be installed in parallel with the battery in your tow vehicle. When the 7-way trailer plug is connected, both batteries power the RV. Do not allow it to discharge your tow vehicle battery below the level required to start the engine. To prevent this from occurring, disconnect the 7-way trailer plug or install a battery isolator. When the tow vehicle engine is operating with the RV connected, the tow vehicle charging system will charge both batteries.

Replacement and Maintenance

Some equipment in your RV will draw small amounts of current even when turned OFF. To prevent the auxiliary battery from being discharged when your RV is not connected to shore line power, disconnect the auxiliary battery negative cable at the battery. During storage, it is important to check the voltage monthly and recharge the auxiliary battery as needed. If you remove the auxiliary battery from your RV, store it in a dry, cool area per the manufacturer's instructions.



When it is time to replace the auxiliary battery, **Group 27 or Group 31 true deep cycle batteries are recommended to increase run time of electrical components while dry camping (operating solely on battery power).**

Do not reverse the positive and negative battery cables (doing so will blow the reverse polarity fuse(s) that protect the power converter).

Please contact the battery manufacturer for additional information on the auxiliary batteries.

Battery Isolator For Your Tow Vehicle (customer supplied)

You may want to consider the installation of a battery isolator on your tow vehicle as a convenience feature:

- It receives current from the tow vehicle alternator and controls distribution of energy to both the RV auxiliary battery and the tow vehicle battery.
- It serves as a check valve to prevent energy from being drawn from your tow vehicle chassis battery (so you can start your tow vehicle engine).

Your dealer can assist you with the selection, purchase and installation.

DC to DC Power Converter (Customer Supplied)

If installing lithium batteries in the recreation vehicle, install a DC to DC power converter between the tow vehicle battery charge line and the trailer lithium battery(s) to prevent lithium battery damage.

DISCONNECT SWITCH (IF EQUIPPED)

The fuse panel disconnect switch is typically located in an enclosed exterior compartment. The style of the disconnect switch may vary per model. **This switch DOES NOT shut off all power**, but only shuts off the 12-volt DC power to the main 12-volt fuse panel, and the interior of the vehicle. Batteries can still be trickle charged by the converter, and there will still be power to some devices.

Rotating Dial Disconnect Switch

When this switch is ON, there will be a green area showing a "1" along the top of the switch. To turn the switch OFF, turn it counter-clockwise until you see the red area along the left side of the switch showing a "0" (zero).

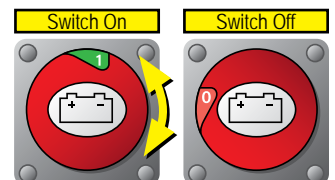

Rotating Dial Disconnect Example

Lever Type Disconnect Switch

To operate this switch, turn the lever counter-clockwise to turn off all 12-volt DC power to the fuse panel in the RV. The lever can be removed when off.

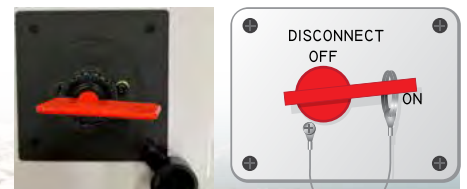

Lever Disconnect Examples



GENERATOR (IF EQUIPPED)

⚠ WARNING ⚠ **⚠ CAUTION ⚠** (See page 54)

The factory-installed generator will produce 120-volt AC power for use when camping in areas where shore power is unavailable. 120-volt power from the generator is output to the AC distribution center by way of a factory-installed automatic transfer switch. In the default mode, the automatic transfer switch connects the generator to the AC distribution center when the generator is operating and shore power is disconnected.

Before starting the generator

1. Make sure the carbon monoxide detector is working.
2. Turn "off" air conditioners and all other appliances.
3. Check for fuel, exhaust and coolant leaks.



STOP the generator immediately if there is a fuel, exhaust, or coolant leak and have it repaired!

To start the generator manually

1. Press the operation control switch to start the generator. Depending on the outside temperature, preheat can take up to 15 seconds.
2. The hour meter will monitor minutes of usage when the generator is running.
3. Before stopping the generator, turn off air conditioners and large electrical loads and allow the generator to run 3 to 5 minutes to cool down. Flip the red start/stop switch to stop.

Maintenance

With the exception of simple items such as normal maintenance (i.e., oil changes, etc.), all service work should be done by a repair facility authorized by the generator OEM. Improper adjustments can damage the generator and electrical appliances, and can result in a safety hazard. If any discrepancy or problem is noted, contact your dealer for assistance.

Exercising Your Generator

It is important to run your generator regularly to keep everything in good working order and avoid fuel varnishing, which can affect performance if the generator is stored for an extended time.

Lack of exercise can cause moisture build-up and fuel system degradation that make it run poorly. In as little as 30 days, the fuel in gasoline-powered generators can begin to gum and varnish the fuel system. Fuel varnishing results in hard starting and surging (a surging generator never settles at a stable operating speed).

To prevent such problems, it is recommended to run gasoline generators at a minimum of 50 percent capacity (2000-watts, or one air conditioner for a 4000-watt set) for two hours once every four weeks. This is necessary to help keep moving parts lubricated, expel moisture and control fuel varnishing in the carburetor. A two-hour exercise period is preferable to several short periods. While traveling, this can be accomplished by running the air conditioning.

For more information on generator safety, operation, and maintenance, refer to the generator owner's manual.



SOLAR PREP (IF EQUIPPED)

⚠ CAUTION ⚠ (See page 54)

Your recreation vehicle may be wired with a connection for the solar panel(s) and solar controller(s) to charge the battery. These come in 3 configurations:

1. An exterior port on the side wall, A-frame, or in the utility center that allows a suitcase style controller/solar panel combo to be plugged in. This port is wired to the battery via a 20-amp 12-volt circuit breaker.
2. A roof mounted port for a solar panel connection, and wiring to a location in an interior or basement wall where a solar controller may be installed. The capped off wiring in the wall for the controller then continues on to chassis ground and to the battery through a 30-amp 12-volt circuit breaker. A decal on the wall shows the wiring location, and a diagram of where to mount the controller.
3. A roof mounted port for a solar panel connection, and wiring to a location in the front basement compartment where a solar controller may be installed. The capped off wiring in the basement compartment then continues on to chassis ground and to the battery through a 30-amp 12-volt circuit breaker, and to a JAYCOMMAND/TravelLINK control panel used to manage the system. A decal on the basement wall panel shows the wiring location for the controller.



Contact your dealer for help with your solar installation. You can also find more info at WiredForSolar.com.

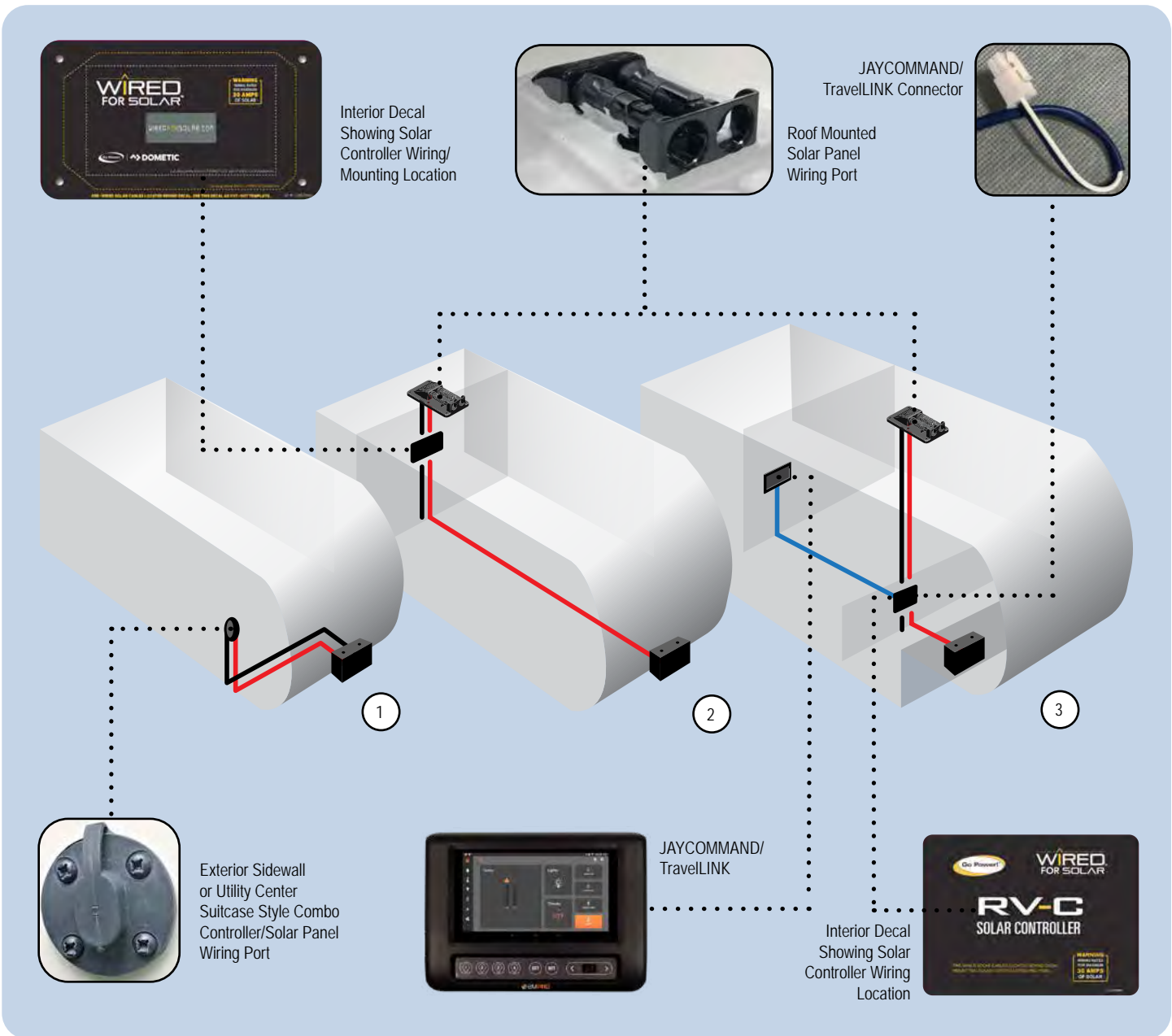



ELECTRICAL

SOLAR PACKAGE (IF EQUIPPED)

⚠ CAUTION ⚠ (See page 54)

Your recreational vehicle may be equipped with a factory installed solar panel kit that includes the solar panel(s) and solar controller(s). For care and operation, please refer to the manufacturer's instructions provided with your RV.

SOLAR PACKAGES	<i>OVERLANDER EXT</i>	<i>OVERLANDER 4</i>	<i>OVERLANDER 2</i> 	<i>OVERLANDER 1</i> 
NOMINAL 200W SOLAR PANELS	6	4	2	1
100AH LITHIUM SELF-HEATED BATTERIES	6	2	-	-
SOLAR CONTROLLER	100-AMP MPPT	60-AMP MPPT	30-AMP MPPT or 30-AMP DIGITAL PWM	30-AMP DIGITAL PWM
INVERTER	3000W SPLIT PHASE/ CHARGER	3000W SPLIT PHASE/ CHARGER	1800W RV-C or 1800W W/ DISPLAY	-
DC/DC POWER CONVERTER	X	X	-	-
SOFT START POWER SAVER 15K A/C W/ HEAT PUMP	LIVING ROOM	LIVING ROOM & BEDROOM	-	-
12-VOLT 13.5K AC	BEDROOM	-	-	-
BATTERY MONITOR	X	X	-	-
ENERGY MANAGEMENT SYSTEM	X	X	-	-
GENERATOR OPTION CAPABLE	X	5TH WHEEL ONLY	-	-
HEAVY GAUGE STEEL BATTERY ENCLOSURE	X	X	-	-

Solar Controller

Regulates voltage between the solar panels and the batteries. MPPT controllers are more efficient than standard controllers.

Inverter

Converts 12-volt DC power to 120-volt AC.

DC/DC Power Converter

Adjusts DC voltage between the tow vehicle and the RV batteries.

Soft Start/Power Save AC

Lowers AC startup and running power requirements.



12-volt AC

Air conditioning operates exclusively on 12V battery power.

Energy Management System

Monitors and manages RV power consumption to avoid nuisance circuit breaker tripping.

NOTE

When adding or changing solar panels or lithium batteries, the new items must be identical to the factory installed parts.



WARNING

ELECTRICAL SYSTEMS MAINTENANCE (page 38)

Use caution when using metal tools. If a tool contacts a battery terminal or metal connected to it, a short circuit could occur which could cause personal injury, explosion or fire.

12-VOLT FUSE PANEL (page 38)

Replacement fuses must be of the same voltage, amperage rating and type. Never use a higher rated replacement fuse; doing so may cause a fire by overheating the RV wiring.

12-VOLT DC/USB OUTLET (page 39)

Keep the protective dust cap on the 12-volt DC/USB outlet when not in use to prevent intrusion of foreign material and potential short circuit conditions.

TIRE PRESSURE MONITOR SYSTEM (page 42)

FAILURE TO ACT IN ACCORDANCE WITH THE FOLLOWING WARNINGS MAY RESULT IN SERIOUS PERSONAL INJURY OR DEATH!

The TPMS system is designed to monitor tire pressure and temperature. It is not designed to provide warning of sudden critical tire damage and blowout caused by external effects. The driver should react promptly to any warning and correct the problem.

Tires can fail for other reasons besides low pressure, high temperature or overloading. Always be on the alert for other tire problems as indicated by unusual noises, vibrations, uneven tread wear, or bulges on the tires. If any of these symptoms occur, have the tires inspected immediately by a tire professional.

AUXILIARY BATTERY (page 49)

Do not store anything inside the battery compartment(s) or near the batteries that could touch the battery or battery cable terminals. Contact with the battery or battery cable terminals could cause an electrical short circuit, discharge the batteries, or start an electrical fire.

Keep sparks, cigarettes and flames away from the batteries as the hydrogen gas they create may explode. Do not connect a booster battery or other power source that outputs more than 14.2-volts DC to lead acid or AGM batteries. Use adequate ventilation when charging or using batteries in an enclosed space. Remove metal jewelry and always wear eye protection when working around batteries.

Do not allow battery electrolyte (acid) to come into contact with skin, eyes, fabric or painted surfaces. Electrolyte is a sulfuric acid solution that could cause serious personal injury or property damage. If your hands, eyes, clothes or the painted surface of your motor home are exposed to electrolyte, flush the exposed area thoroughly with water. If electrolyte gets in your eyes, immediately flush them thoroughly with water and get prompt medical attention.

TESTING THE CAMPSITE POWER CONNECTION (page 45)

30 AMP POWER CORD & 50 AMP POWER CORD (page 45)

Do not hook the power cord to any receptacle until you have verified proper polarity and grounding.

DO NOT plug the shore power cord into a campsite receptacle(s):

- That has reverse polarity
- That has non-functioning ground circuits
- That shows outward signs of heat damage.

Doing so may result in property damage or serious injury. Plugging the shore power cord into an incorrectly wired power source could damage the recreation vehicle electrical system and result in severe or fatal injury. Damage or injury resulting from connection to malfunctioning or improperly wired power sources is not covered by your recreation vehicle warranty.

Do not use any cheater plug, adapter or extension cord to reconfigure incoming AC power or break the continuity of the circuit connected to the grounding pin.

Do not connect the power cord into an outlet that is not grounded, or adapt the power cord plug to connect it to a receptacle for which it is not designed.

Do not remove the grounding pin to connect to a non-grounded receptacle. Removal of the ground pin disables an important safety feature designed to prevent shock and electrocution hazards.

Do not connect the power cord to an extension cord. Use of an improper extension cord will cause overheating of the cord as well as potentially causing premature failure of the AC equipment.

The power cord must be fully extended when in use and not left coiled in the electrical compartment or on the ground. A power cord left coiled may potentially create enough heat to melt its protective casing.

It is the responsibility of the owner of the electrical receptacle to ensure that the receptacle is properly wired and grounded. Reverse polarity and/or improper grounding of your RV can cause property damage or serious personal injury.

120-VOLT, 30-AMP AC ELECTRIC SYSTEM (page 45)

Make certain the external power source you connect the power cord to is a properly wired 30-amp NEMA TT-30 RV receptacle and not 240-volt AC. **PLUG INTO 30-AMP SERVICE ONLY.**

Circuit breakers and fuses will not offer complete protection of the electrical system in the event of power surge or voltage spike.

120-VOLT, 50-AMP AC ELECTRIC SYSTEM (page 45)

Circuit breakers and fuses will not offer complete protection of the electrical system in the event of power surge or voltage spike.

Make certain the external power source you connect the power cord to is a properly wired 50 AMP NEMA 14-50 RV receptacle and not 240 volt AC. **PLUG INTO 50 AMP SERVICE ONLY.**

WARNING

ELECTRICAL WARNING Continued

120 VOLT CIRCUIT BREAKERS (page 48)

Replacement circuit breakers must be of the same voltage, amperage rating and type. Never use a higher rated replacement circuit breaker. Doing so may cause a fire by overheating the RV wiring.



GENERATOR (page 50)

CARBON MONOXIDE IS DEADLY! Do not run the generator when your RV is indoors or in a confined space. Asphyxiation or carbon monoxide poisoning hazards exist whenever generator exhaust gasses can accumulate.

MOVING PARTS AND ELECTRICITY can cause severe personal injury or death. To reduce exposure to these hazards, always disable AGS (if equipped) before:

- Sleeping in vehicle, unless vehicle has a working CARBON MONOXIDE detector.
- Parking vehicle in garage or confined space.
- Parking vehicle for storage.
- Servicing vehicle for storage.
- Servicing generator.
- Servicing batteries.
- Servicing appliances or electrical systems.
- Fueling the vehicle.

DO NOT run the generator or use the AGS AUTO ON or QUIET ON modes (if equipped) when your RV is indoors or in a confined space. Asphyxiation or carbon monoxide poisoning hazards exist whenever generator exhaust gasses can accumulate.

CAUTION

ELECTRICAL CAUTION

TIRE PRESSURE MONITOR SYSTEM (page 42)

TPMS sensors – **DO NOT MOVE WITH THE TIRES!**

The TPMS sensor on the front tire (on either side of the trailer) **STAYS** at the front tire position when rotating tires.

The TPMS sensor on the middle tire (on either side of a 3-axle trailer) **STAYS** at the middle tire position when rotating tires.

The TPMS sensor on the rear tire (on either side of the trailer) **STAYS** at the rear tire position when rotating tires (on both dual and triple axle trailers).

This guarantees tire pressures displayed on the touchscreen are accurately showing the correct tire locations on the trailer.

POWER CONVERTER (page 47)

It is important that the fluid level of any connected batteries be checked on a regular basis. All batteries will “gas” and lose some fluid when continuously connected to any charging source (does not apply to “gel-cell” batteries).

120 VOLT CIRCUIT BREAKERS (page 48)

Circuit breakers and fuses will not offer complete protection of the electrical system in the event of power surge or voltage spike.

SOLAR PACKAGE & SOLAR PREP (page 52)

Adding solar panels or equipment will affect the carrying capacity of your recreation vehicle. Vehicle weight ratings should be considered before adding these components.

Never connect your tow vehicle harness to a recreation vehicle equipped with a lithium battery without a DC/DC power converter installed. Direct tow vehicle charging may cause permanent damage to the lithium battery unless the vehicle charge line is properly voltage regulated or disconnected.

GENERATOR (page 50)

Excessive cranking can overheat and damage the generator starter motor. Do not crank for more than 20 seconds at a time. Wait at least two minutes before trying again. If the generator does not start after the third try, refer to the generator manufacturer’s user manual for more information.

For better performance and engine life, especially in colder weather, let the generator engine warm up for two minutes before turning “on” 120-volt appliances.

SECTION 7: FUEL & PROPANE SYSTEM



EXHAUST GAS FUMES

⚠ WARNING ⚠ (See page 59)

To prevent inhaling exhaust gases, follow these guidelines:

- Always shut OFF the tow vehicle engine, generator engine (if applicable), etc., while refueling.
- Do not run the tow vehicle engine, generator engine (if applicable), etc., in confined areas, such as a closed garage, any longer than needed to move your RV in or out of the area.
- Windows should be closed while driving or running the generator (if equipped) to avoid drawing dangerous exhaust gases into the RV.
- If you suspect that exhaust fumes are entering the RV, have the cause determined and corrected as soon as possible.

The best protection against carbon monoxide entry into the RV is a properly maintained ventilation system and an active carbon monoxide detector. To allow for proper operation of the RV ventilation system, keep the ventilation inlet grill(s) clear of snow, leaves or other obstructions at all times.

See "SECTION 2: OCCUPANT SAFETY" on page 8 for additional information on carbon monoxide safety.

PROPANE GAS SYSTEM

⚠ WARNING ⚠ (See page 59)

Propane or LP (liquefied petroleum) gas is an efficient form of energy when proper handling and safety precautions are observed. The propane system in your RV furnishes the fuel for cooking, heating, hot water and can be an alternative energy source for refrigeration.

Propane is heavier than air; and tends to flow to lower areas and will sometimes pocket in these low areas, such as the floor. Your RV is equipped with a propane alarm (refer to "**COMBINATION CARBON MONOXIDE /PROPANE ALARM**" on page 9).



The propane fuel system is comprised of numerous components such as the propane container, hoses, the propane gas regulator, piping, and copper tubing to each appliance.

Although your RV has been carefully tested at the factory, and by your selling dealer for leakage, travel vibrations can loosen fittings. Have the propane system checked at all connections soon after the purchase of your RV, and after the initial filling of the propane tanks.

Continued periodic checks of the propane system at 5,000 miles of travel (or at least once a year), by a qualified propane service representative as part of your normal maintenance is recommended. Hand tighten the LP gas system valves only, do not use a wrench or pliers as over tightening may damage the valve seals and cause them to leak.

NOTE

All propane lines have been checked with air pressure at the time of manufacture. Dealers are required to recheck and adjust pressure before retail delivery.

Propane Gas Container

⚠ WARNING ⚠ (See page 59)

DOT (Department of Transportation) cylinders are transportable and are commonly used on RVs. DOT propane cylinders are required to be removed from the RV for filling and must be filled by weight by a qualified propane facility. DOT Propane cylinders are equipped with an OPD (over fill protection device) designed to reduce the potential of overfilling.

DOT cylinders are typically marked with "top" or an arrow to indicate the correct orientation of the cylinder(s). Do not mount, store or transport any cylinder other than in the proper position indicated.

Be sure to securely re-install DOT cylinder(s) to the RV after they have been removed for filling or replacement. Always close the service valve and install a dust cap or plug when transporting or storing disconnected containers whether full or empty.

NOTE

Tanks are to be installed, fueled and maintained in accordance to State and Local codes, rules, regulations or laws.

Propane is a true gas compressed into a liquid form. As the fuel is released from the container, it changes to vapor which is then used for the operation of the appliances. Propane will not run through the appliances in the liquid state.

Propane expands 1½ percent for every ten degrees of increase in temperature. It is imperative to leave sufficient space inside the container to allow for natural expansion of gas during warmer weather.

The main shut off valve must be kept closed at all times unless you are using the propane system or filling the propane cylinder. When the cylinder is disconnected from the hose, install the valve cover that is attached to the container.

Close the propane cylinder main shut off valve by hand tightening only. Use of tools creates a potential to over tighten the valve (damaging the interior seals on the cylinder valve seat). If this type of damage occurs, the cylinder will not close properly.

Servicing or Filling

Have the RV checked for leaks at the connections on the propane system soon after the purchase and the initial filling of each propane cylinder.

When you have a new cylinder filled for the first time, make sure your propane supplier purges your new cylinder of trapped air. Otherwise, an improper mixture of gas and air will make it impossible to light your propane appliances.

LP Gas Container Overfill

Never allow your propane tank to be filled above the maximum safe level. Overfilling the propane container above the liquid capacity indicated on the container, could allow liquid propane to enter the system that is designed for vapor only, creating a hazardous condition.

The propane piping system is designed for use with propane only. Do not connect natural gas to this system.

Refer to your Customer Information Packet for more information on the LP gas system components.

Maintenance

Propane gas is normally non-corrosive - you need not worry about the inside of your container. However, the outside should be kept free from rust by a periodic coat of paint in a light reflective color. Rust, scratches and/or dents can affect the safety of the cylinder. Inspect the cylinder at regular intervals. If there is a problem, have it evaluated by a qualified technician and discard it. DOT requires that a visual inspection be made prior to each filling.

Any cylinder that has been exposed to fire, leaks, or seems damaged should not be refilled.

Do not attempt to repair any containers, container valves, regulator or appliances by yourself. Use only trained certified propane gas service technicians to perform repairs.

Propane Cylinder Recertification

DOT cylinders may only be used for 12 years after their manufacture date (the number of years for certification may vary in your area). After that, the cylinders must be "recertified" which provides another five years of use.

The cylinders can be recertified every five years thereafter. Federal DOT (Department of Transportation) regulations require periodic inspections and re-qualifications of the propane cylinders. **DO NOT USE** damaged or rusted containers.

Verify with your local propane dealer that all required inspections and certifications have been completed on the propane cylinder within the correct time period before refilling the cylinder. Have the LP system checked for leakage each time a cylinder is refilled or after any part of the propane system has been disconnected.

Hoses, Pipes, Tubes and Fittings

The hoses, pipes, tubes and fittings used in your propane system are designed to withstand pressures exceeding those of the propane system. However, because environment and time can both contribute to the deterioration of these components, they must be inspected for wear at regular intervals.

Be sure to inspect the hose before each season and when having the tank refilled. Look for signs of deterioration such as cracks or loss of flexibility. When replacing the hose or other propane components, make sure to always replace them with components of the same type and rating (check with your dealer).

Two Stage Propane Regulators

⚠ WARNING ⚠ (See page 59)

A propane regulator's function is to reduce the pressure from the propane container(s) to a safe and consistent low operating pressure.

The regulator may be adjusted by your dealer or qualified propane service technician for optimum performance (this adjustment should always be made with a properly calibrated manometer). If the pressure is too high, it affects performance and safety; if the pressure is too low, your appliances will not operate correctly.

If your RV is equipped with the "automatic" two-stage regulator, with both cylinders full of propane, turn the lever on the regulator towards the cylinder you wish to use first. This will now be the "supply" cylinder and the other the "reserve". Slowly open both cylinder valves. The indicator on top of the regulator will turn bright green. When the cylinder becomes empty, the indicator will change to bright orange. Now turn the regulator lever to the side of the "reserve" cylinder and the green signal should return. You may now remove the empty cylinder to have it refilled without interrupting the flow from the full bottle. After filling the cylinder, connect the pigtail hose and slowly open the bottle valve.

Refer to the manufacturer's information included in your Customer Information Packet and follow all safety instructions and warnings.



PROPANE USE AND SAFETY

Propane is a colorless and odorless gas that, in the liquefied state, resembles water. An odorant (usually a sulfur compound) is added as a warning agent. If you smell propane within the RV, quickly and carefully perform the procedure listed on the propane system label. This label has been placed in the RV near the range, for models equipped with a propane system.

When a propane container is low, there may be a concentration of an onion or garlic-like odor, which can be mistaken for a propane gas leak. After the propane container has been refueled, the odor will usually disappear. If not, turn off the valve(s) and have the propane system inspected by your dealer or qualified propane service representative.

Propane Leak Test

⚠ DANGER ⚠ (See page 60)

Leaks may be found easily with a soapy water solution. Do not use a solution containing ammonia or chlorine when locating leaks. These products are corrosive to copper gas lines and brass fittings, which could result in deterioration of the copper and brass components. Apply the soapy solution to the outside of the gas piping fittings. If a leak is present, the soapy solution will "bubble" at the leak point. If a leak is indicated, shut off the propane system valve(s) and contact your dealer or qualified propane service representative immediately.

Using the Propane System

Use the following steps for propane operation:

1. Close ALL burner valves and controls.
2. Open the main valve in the propane tank slowly to avoid a rush of propane vapor through the excess flow valve, causing propane "freeze-up." Should you experience propane "freeze-up", close the main valve and wait 15 minutes before trying again.
3. Listen carefully as propane begins to flow. If a hissing noise is heard for more than one or two seconds, close the main valve and contact your dealer to have the propane system tested.
4. Light the appliances as needed and directed in the appliance manufacturer's owner manual located in the Customer Information Packet.

Keep the propane container valves closed at all times unless you are using the propane gas system or are having the propane container filled.

Make sure that you read and fully understand ALL safety requirements for handling and operation of the propane system.

The propane system must be handled with care. If you have any questions or concerns, consult with your dealer and/or the specific appliance manufacturer.

If you have double cylinders on your RV, use only one at a time. Otherwise, the propane supply will be drawn equally from both cylinders until the supply has been totally exhausted. Using one cylinder until it is empty and then using the second cylinder will allow you to fill the empty cylinder at your convenience without running out of propane.



Cooking With Propane Gas

⚠ DANGER ⚠ **⚠ WARNING ⚠** (See page 60 & page 59)

Unlike homes, the amount of oxygen supply is limited due to the size of the RV. Proper ventilation when using the cooking appliance(s) will help avoid the danger of asphyxiation.

Calculating Propane Gas Usage

Most RV gas appliances are operated intermittently, and each has a different BTU rating. You will need to consider this when planning your propane supply and consumption. During cool temperature or high wind conditions, furnace consumption can be extremely high.

To calculate your propane supply, take the BTU ratings for your propane appliances and divide that into the BTU availability. Each gallon of propane gas (3.785 liters) produces about 91,500 BTU's (96,528 kilojoules) of heat energy.

NOTE

Unless there is heavy use of hot water, the on-demand water heater consumption of propane is minimal.

Propane consumption chart

The following chart provides average propane consumption information.

Appliance	Average BTU Consumption per Hour
On Demand Water Heater	60,000 (max setting)
Refrigerator	1,200 – 1,500
Furnace	35,000 – 40,000
Range/oven	7,100
Range, rear burner	6,500
Range, front burner	9,000
Outside Grill	10,000

Traveling with Propane

⚠ DANGER ⚠ (See page 60)

Make certain your propane tank is properly fastened in place, and your tank valves are closed during travel.

FUEL & PROPANE SYSTEM

USING THE FUEL STATION (IF EQUIPPED - SEISMIC ONLY)

Automotive Fuel Safety

⚠ DANGER ⚠ (See page 60)

Your RV may be equipped with a single factory-installed fuel tank that supplies fuel to the optional fuel station and/or optional generator. It is critical to understand the danger associated with fuel.



Fuel Station

Read, understand and follow all safety information in the fuel station manufacturer's manual before operating the fuel station. If you need further assistance, consult with your dealer or Customer Service.

Fuel Filler Cap

⚠ WARNING ⚠ (See page 59)

Remove the fuel filler cap by slowly turning it counterclockwise and waiting for any "hiss" noise to stop. Then unscrew the cap all the way.

To close the fuel filler cap, securely turn the cap clockwise until you hear clicking sounds. If you need to replace the fuel tank filler cap, use only a cap specified for your fuel station.

Grounding Clip

A grounding clip is attached to the fuel nozzle. The flow of fuel can cause a static charge. **THE GROUNDING CLIP MUST BE ATTACHED TO THE COMPONENT OR VEHICLE BEING FUELED IN ORDER TO BOND/GROUND IT TO THE RV.**

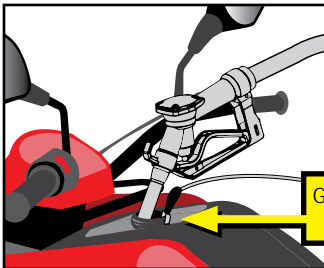

Grounding Clip Attached to Tank



Grounding Clip Inside Fuel Station

Fuel Pump Momentary Switch

⚠ WARNING ⚠ (See page 59)

The fuel pump momentary switch runs the fuel pump for 15 minutes, and then stops. It is typically located inside the RV on the command center panel next to the entrance door. Both the inside fuel pump switch and the master/emergency disconnect switch must be turned on to dispense fuel.

To turn this switch "ON" press it **one** time. To turn it "OFF" press it **two** times.

When the fueling station is not in use, the fuel pump switch and the master/emergency disconnect switch should both be turned "OFF".



Fuel Tank(s) Fuel Selection (if equipped)

⚠ DANGER ⚠ ⚠ WARNING ⚠ (See page 60 and page 59)

The factory-installed fuel tank must be filled with the fuel type recommended by the generator manufacturer **or** with the fuel type recommended by your aftermarket vehicle and/or equipment manufacturer (if no generator is installed).

The fuel tanks are specifically made for unleaded gasoline. Use clean, fresh unleaded fuel not containing a blend of more than 15% Ethanol. The fuel tank(s) are not compatible with any other fuel blends or diesel fuel.

The tanks have an aluminized coating on the steel to help stop corrosion inside the tank(s). **Diesel fuel is corrosive to this aluminized coating and will cause internal damage to the tank(s).**

Master/Emergency Disconnect Switch

⚠ CAUTION ⚠ (See page 60)

The fuel station is equipped with a red plunger type disconnect switch that will shut off the fuel pump and fuel flow in case of an emergency. The disconnect switch can be found next to the fuel station behind the skirting.



Master/Emergency Fuel Disconnect Location

NOTE

This switch should be "OFF" position (knob pushed in) when the fuel station is not in use.

Fuel Gauge

Your RV is equipped with one of the following fuel gauges to monitor the amount of fuel available for use. The fuel gauge is typically located on the command center panel.

- **Command Center Panel:**
The fuel gauge is located on your command center panel along with your momentary switch.
- **BMPro (If Equipped):**
If equipped, your Fuel Station fuel levels can be checked from your JAYCOMMAND/ TravellINK (BMPro) control panel under the energy section. For more details see "JAYCOMMAND®/TRAVELLINK® SYSTEM (IF EQUIPPED)" on page 41.



Command Center Panel Example

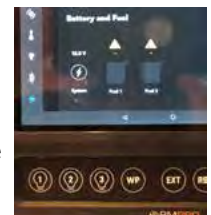

BMPro Example

NOTE

Do not pump the fuel tank completely dry as contaminants from the bottom of the tank may enter the pump.

NOTE

To avoid running the battery down, always make sure that the fuel gauge selector switch is in the OFF position.

FUEL & PROPANE SYSTEM

Dispensing Fuel

 (See page 60)

Be sure the fuel tank has fuel in it prior to operating the fuel pump. Make sure the fuel is not contaminated with debris.

1. Attach the grounding clip to the item or vehicle being fueled.
2. Outside the RV at the fueling station, pull the master/emergency disconnect switch to the "ON" position.
3. Inside the RV, press the fuel pump momentary switch **one** time. Pushing this switch turns on the pump, and a timer which will automatically turn off the fuel pump after 15 minutes has elapsed (pressing this switch **two** times turns off the timer and the pump).
4. Outside the RV, insert the fuel nozzle into the receiving tank and squeeze the nozzle handle to dispense the fuel. Fueling should begin in 15 to 20 seconds.

5. When fueling is complete, release the nozzle handle to stop the flow of fuel. Replace the nozzle back into the fueling station storage box.
6. Turn off the master/emergency disconnect switch by pushing the knob in.
7. Disconnect the grounding clip.
8. Inside the RV, press the fuel pump switch next to the fuel gauge **two** times to cancel the timer and turn off the pump.

If the timer shuts off the pump before fueling is completed, turn on the fuel pump switch inside the RV. This will start another 15-minute cycle.

NOTE

Running the fuel dispensing pump for more than 5 minutes with the fuel nozzle closed will reduce the fuel pump motor life.



EXHAUST GAS FUMES (page 55)

Avoid inhaling exhaust gases as they contain carbon monoxide, which is a potentially toxic gas that is colorless and odorless.

If you are in a recreation vehicle with either a nearby tow vehicle engine running or the generator (if equipped) running, there is a potential for exhaust fumes to filter back into the recreation vehicle.

PROPANE GAS SYSTEM (page 55)

Propane cylinders should not be placed or stored inside RV. Propane cylinders are equipped with safety devices that relieve excessive pressure by discharging propane into the atmosphere. Propane gas is highly flammable, can lead to fire or explosion, and result in death or serious injury.

5.8.1.2.1

PROPANE GAS CONTAINER (page 55)

DOT propane cylinders must be transported and stored in an upright position so the pressure relief device will function properly. Laying a DOT propane cylinder on its side may potentially create a very dangerous situation.

The pigtail hose must be installed to avoid tension or pulling stress at either end of the hose. Keep the pigtail hose away from sharp edges of the cylinder collar, rigid corners, walls, doors or other compartment structures including the cover.

Before entering a propane or fuel service station make sure all pilot lights are extinguished. Shut off gas to all appliances by closing the propane gas main shut off valve. Always shut OFF any engine before refueling. Do not smoke and do not operate other ignition sources while refueling.

If you suspect your propane container has been overfilled, contact your dealer or a qualified propane technician for assistance immediately. Do not attempt to service a propane container overfill yourself.

FUEL & PROPANE SYSTEM WARNING

7

FUEL & PROPANE SYSTEM

FUEL FILLER CAP (page 55)

Do not replace the fuel fill cap with one of a different type. Use of a substitute cap may create excessive fuel system pressure, resulting in fuel station damage and improper operation in a collision.

Fuel can spray out on you if you open the fuel filler cap too quickly. This can happen if your tank(s) is nearly full and is more likely to happen in hot weather.

FUEL PUMP MOMENTARY SWITCH (page 55)

IF THE FUEL STATION EQUIPMENT DOES NOT FUNCTION AS INTENDED, DISCONTINUE USE AND HAVE THE FUEL STATION SERVICED BEFORE RESUMING USE.

PROPANE REGULATORS (page 56)

Propane regulators must always be installed with the regulator vent facing downward. Regulators that are not located in baggage compartments have been equipped with a protective cover. Make sure the regulator vent faces downward and (if applicable) the cover is in place to minimize vent blockage that could result in excessive gas pressure causing fire or explosion.

5.8.1.2.7

COOKING WITH PROPANE GAS (page 57)

Do not turn gas range burner controls to ON and allow gas to escape before lighting.

Do not use portable fuel burning equipment (i.e., wood and charcoal grills or stoves) inside the recreation vehicle.

FUEL TANK FUEL SELECTION (page 57)

Working with fuel can be dangerous. Serious injury or death could result from improper handling of the generator, fuel station and fuel.



FUEL & PROPANE SYSTEM CAUTION

MASTER/EMERGENCY DISCONNECT SWITCH (page 55)

Skirt edging can be very sharp. Exercise caution when reaching behind the skirt to operate the emergency cutoff switch.



FUEL & PROPANE SYSTEM DANGER

PROPANE LEAK TEST (page 57)

Never use an open flame to test for a propane leak. Do not check for leaks using products that contain ammonia or chlorine as these products can cause cracks to form on the metal tubing and brass fittings.

TRAVELING WITH PROPANE (page 57)

All pilot lights, appliances and their igniters (see operating instructions) should be turned off before refueling of motor fuel tanks and/or propane containers.

These can cause ignition of flammable vapors, which can lead to a fire or explosion.

FAILURE TO COMPLY COULD RESULT IN FIRE, DEATH OR SERIOUS INJURY.

DISPENSING FUEL (page 55)

STATIC ELECTRIC SPARK EXPLOSION HAZARD.

Do not use cell phones or other electronic devices while dispensing fuel.

MAKE SURE THE FUEL PUMP IS PROPERLY GROUNDED.

Make sure the fuel nozzle grounding clip is always attached to the component or vehicle receiving fuel.

Make sure the pump is properly maintained as instructed by the fuel pump manufacturer's operator manual. Make any necessary repairs prior to operation.

NO SMOKING! Before dispensing fuel turn off all engines, fuel burning appliances, and their igniters. Do not dispense fuel within 20ft of an ignition source.

Failure to comply could result in fire, death or serious injury.

COOKING WITH PROPANE GAS (page 57)

Do not use cooking appliances for comfort heating, Can lead to carbon monoxide poisoning, which can lead to death or serious injury.

5.8.1.2.2

FUEL TANK FUEL SELECTION (page 57)

Before filling the RV fuel tank(s), be sure the RV is level from side to side and front to back to avoid potential overfilling. DO NOT over fill the factory-installed fuel tank(s). Once the pump has shut off by itself, do not try to put more fuel in the tank. Overfilling the tank(s) may result in fuel leakage and damage to fuel system components. Follow all safety information in this manual and the OEM operator's manual. Failure to comply could result in death or serious injury.

AUTOMOTIVE FUEL SAFETY (page 57)

Automotive fuels can cause serious injury or death if misused or mishandled. If you have further questions, consult your dealer or Customer Service for assistance.

Always shut OFF the tow vehicle engine while refueling.

Do not bring or store fuel or other flammable liquids inside the RV because a fire or explosion may result.

Before refueling, extinguish all smoking materials and any open flames.

Before refueling, always turn OFF all spark producing appliances (i.e., water heaters, furnaces, etc.).

Do not overfill the fuel tank(s). The pressure in an overfilled fuel tank may cause leakage and lead to fuel spray and/or fire.

Fuel spills represent a serious fire hazard and should be cleaned up immediately.

Never restart an engine or re-light any pilot lights while raw fuel is present.

The fuel tanks are specifically made for unleaded gasoline. Use clean, fresh unleaded fuel not containing a blend of more than 15% Ethanol.

FAILURE TO COMPLY COULD RESULT IN FIRE, DEATH OR SERIOUS INJURY.



SECTION 8: PLUMBING SYSTEM



PLUMBING SYSTEM

There are two different water systems in your RV:

- The **fresh water system** consists of the fresh water holding tank, faucets and connections, water pump, water heater, tub/shower. On some models, it may also include the water purification system or outside shower assembly (if equipped).
- Depending on your model, the **waste water system** consists of the grey (wastewater) and black (sewage) holding tanks, drains, and toilet.



Plumbing System Maintenance

- Check all lines and fittings for leaks before each trip or before RV storage as part of your normal maintenance.
- Inspect all faucets, the water purification system (if equipped) and sink connections (including drain baskets or filters).
- At the end of every trip, you should drain any unused water from the fresh water system.

Typically, there are labels affixed to the exterior of the RV sidewall that indicate the locations of the water system drains and fills. Be aware some drain valves may be located inside the RV (once the exterior label is found, go inside to find the drain corresponding location).

Refer to the manufacturer's operating manual included in your Customer Information Packet for the detailed operating, sanitizing, and winterizing information for each water system component.



MONITOR PANEL

Monitor panel locations may vary by model. Typical locations are on the command center panel near the door, on an interior wall, or on the exterior utility center. The monitor panel allows you to monitor the fresh water, grey water, black water and auxiliary battery levels. It operates on 12-volt DC power supplied by either the converter or auxiliary battery. No power is drawn from the battery unless a switch is pushed or turned ON. Fuses for the monitor panel are located in the load center.

Some models may be equipped with a touch screen system that monitors tank levels electronically.



Touch Screen Example

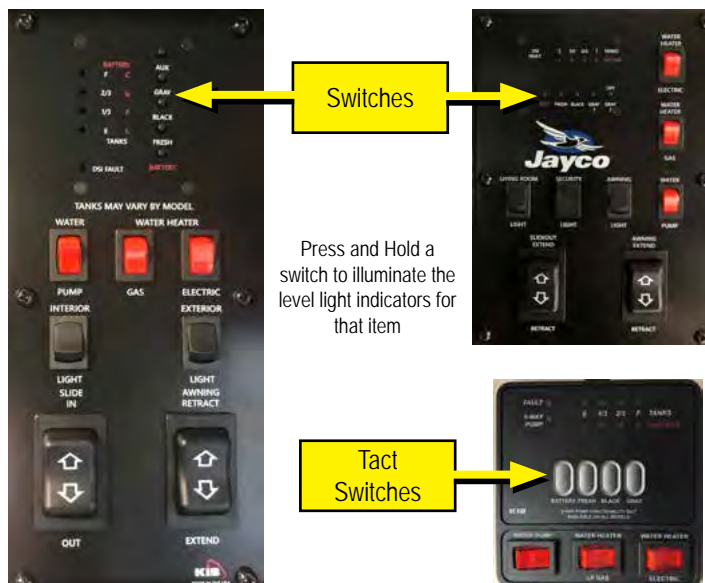

Command Center Examples

NOTE

If your RV has secondary black or gray tanks, there may be an additional tank monitor. It is typically labeled as a convenience center.

PLUMBING SYSTEM

Operation

Press only one switch at a time. As you push either the FRESH, BLK GREY1 or GREY2 switch, one or more LED lights will illuminate indicating the content level for that tank.

Tank monitors on the touch screen have a constant readout. There are no buttons to push. Tank levels are displayed by percentage from 0% to FULL.

Water pump switch (if equipped)

The water pump switch may be located on the monitor panel, the utility center, or both. On some models, the water pump control may be on one of the selectable screens for the touch screen. When the water pump switch is ON (lit), the water pump will run until it reaches 45 lbs. of pressure. It will recycle when pressure drops. Turn the switch OFF when the water pump is not being used.

Water heater switch(s) (if equipped)

Water heater switches will be located on the monitor panel, the command center, or in the case of a touch screen system, on one of the selectable screens of the touch screen. Switches will light up when turned on. The "LP GAS" water heater switch (12V) enables propane operation of the water heater, and the "ELECTRIC switch (120V) enables electric operation of the water heater. Normally both switches should be turned on to provide the fastest hot water recovery time. The water heater can be operated in electric only or gas only modes by pressing each switch independently.

NOTE

If the RV is equipped with an on demand water heater, there will only be an LP Gas switch on the command center panel.

DSI FLT - Direct Spark Ignition Fault (if equipped)

This light will indicate a problem with the LP portion of the water heater. When the LP GAS switch is turned on, the light will blink quickly 3 times and the water heater will ignite. The light will then remain off. If the light comes on and stays on, it indicates the gas side of the water heater has not fired and there is a problem with the igniter.

NOTE

This light will not appear on touchscreens, RV remote controls, or on a Wi-Fi app. It only appears on the Command Center switch panel.

FRESH WATER SYSTEM

⚠ WARNING ⚠ (See page 78)

All water contains contaminant and mineral particles that can cause fresh water system odors. Untreated well water is a major source of water system odors. The fresh water (potable water) system needs periodic sanitization to take care of all the components in the plumbing system to discourage the growth of bacteria and other organisms that can contaminate the water supply. See "SANITIZING/WINTERIZING THE PLUMBING SYSTEM" on page 75 for more information.

You should use a non-toxic drinking water hose dedicated only to supplying the recreation vehicle with fresh water. To reduce the chance of contamination, prevent the openings of the non-toxic drinking water hose from coming into contact with the ground.

Water Pressure Regulator (customer supplied)

⚠ CAUTION ⚠ (See page 79)

Excessive pressure from the water supply source may be encountered in some parks, especially in mountain regions when using the fresh water inlet or black tank flush. Water pressure regulators are available to protect your recreational vehicles plumbing system against such high pressure.



Pressure Regulator Example

Fresh Water Holding Tank

⚠ CAUTION ⚠ (See page 79)

The Fresh Water Holding Tank allows you to have water for camping when you are not going to be attached to a pressurized water connection at the camp site. There may be several ways to fill the fresh water tank depending on the model. For details of each method, refer to "FRESH WATER CONNECTIONS" on page 63 or "UTILITY CENTERS" on page 66. There are plastic overflow tubes in the fresh water holding tank which allow water to flow out of the water tank. Occasionally, you may see water coming from the overflow tubes when the fresh water holding tank is filled. This is normal and can be a result of the recreation vehicle being parked on an incline, or the motion caused by starting or stopping during travel.

12-volt Water Pump

There must be sufficient 12-volt DC power to run the water pump when your recreation vehicle is not hooked up to city water. Once activated, the water pump (also known as the demand pump) will self-prime, and provide water. The water pump continues to run until maximum pressure is achieved. The water pump will automatically re-start when it senses a drop in the water pressure. Some cycling may occur depending on the volume of water being released.

The pump is designed for intermittent use only. Using the pump continuously or with high pressure will shorten the life of the pump and is not covered in your warranty.

The water pump is engineered with a check valve to prevent water from backflowing into the fresh water supply tank.

Maintenance

Periodically check the in-line water pump strainer for accumulated debris. To clean, shut off the water pump, unscrew the clear cap, remove the re-usable metal strainer, clear any debris, then reinstall.



Normal pump maintenance consists of checking and cleaning of the strainer, normal sanitizing and winterizing, and occasionally checking all plumbing hardware and fittings for tightness. Lack of sanitizing can lead to premature pump failure and poor performance over time. Scale build-up on the diaphragm and valves, can cause low flow and leak back (occasional pump cycling with no faucets open or tank filling up when hooked up to city water).

For additional information on the care and operation of the pump, read the safety and operating information in the pump manufacturer's owner's manual.

PLUMBING SYSTEM

Water Pump Switch

Most water pump switches illuminate when the water pump is activated. Typical switch locations are in the back of the unit, on the monitor panel, or the switch may be part of a touchscreen system (if equipped). When the water pump switch is ON the pump runs until 45 lbs. of pressure has been achieved. The red light will stay on.

NOTE

The water pump switches should be in the OFF position when the RV is left unattended for any amount of time.

FRESH WATER CONNECTIONS

Your RV may be equipped with one or both of the following fresh water connections: city water and gravity fill. These connections will include a threaded adapter under a cap and may be found somewhere along the side of the RV on their own or within a Utility Center. For Utility Center configurations see "UTILITY CENTERS" on page 66.

NOTE

Avoid traveling with your fresh water tanks full. Instead fill your fresh water tanks, if needed, at or near your camping destination. If your campsite has a pressurized water source, there is no need to fill your fresh water tank.

Using the City Water Connection

Remove the connection cap and attach a non-toxic drinking water hose to the threaded inlet.

1. The other end of this hose should be connected to a pressurized fresh water source (such as a faucet or spigot). You should use a non-toxic drinking water hose dedicated only to supplying fresh water to the RV.



City Water Connection Example



Elbow Connector

To prevent strain on the threaded connector and crimping of the water hose, for external ports it is recommended to use a 90 degree elbow connector before attaching the fresh water hose to the City Water Connection.

2. Turn ON the water at the water source. Open the cold water supply faucets to bleed air from the water lines. When the water lines are nearly full, you may experience some "air pockets." Allow these to escape before closing the cold water supply faucets.

NOTE

The City Water Connection inlet, when connected to a pressurized fresh water source, sends water through the water lines and fixtures without the use of the pump. For this reason the water pump should be turned off. The fresh water tank cannot be filled using the city water connection unless it is part of a utility center that has a valve configuration that allows it. For utility center valve configurations see "UTILITY CENTERS" on page 66.

3. The water heater will fill first, followed by the supply lines and faucets. Water heater bypass valves must be open to allow water into the water heater. Refer to "Tank Versus On Demand Water Heaters" on page 75 for an explanation on configuring the bypass valves.



Pressure Regulator Example

In order to prevent RV plumbing from being damaged by high water pressure from your water source, it is recommended to install an in-line water pressure regulator between the source and the City Water Connection on the RV.

Additionally to help avoid contaminants in the water, an inline water filter is also recommended when a water filtration option is not already installed.

To disconnect the City Water Connection:

1. Shut OFF the water at the pressurized water source.
2. Disconnect the non-toxic drinking water hose and reinstall the connection cap. The connection cap should always be installed if the city water connection is not in use.

Using the Gravity Fill

You can fill the fresh water tank from a container of fresh water and the gravity water fill inlet if you do not have access to city water.



Low point and fresh water tank drains should be closed.

1. Remove the connection cap and insert a non-toxic drinking water hose (or a funnel) into the gravity fill inlet. The other end of the hose goes into a container of fresh potable water.
2. Pour the fresh water into the gravity fill until the tank is full.
3. When the fresh water tank on the RV is full, remove the non-toxic drinking hose and container from the gravity water fill. Replace the connection cap. This cap should always be installed if the water fill is not in use.



Gravity Water Fill Example

Fresh Water Connection Fill

Used only to fill the fresh water tank. Check your dial settings in the section covering "UTILITY CENTERS" on page 66. Depending on the utility center being used this will either require a pressurized water source, or have the ability to siphon fill using the on board pump.

If no matching utility center is listed, this will use a pressurized source only.

When tank is full, turn off the water source, disconnect the hose. Fresh water tank level can be checked at the monitor panel. **Do not overfill the water tank.**



PLUMBING SYSTEM

WATER PURIFICATION SYSTEM (IF EQUIPPED)

⚠ CAUTION ⚠ (See page 79)

The canister filter is the primary filter used for the complete water system. If the water supply has not been used for some time, allow the water to flow for several minutes to flush the system.

Filters should be replaced at the beginning of each camping season or if they have come into contact with contaminated water. Also, if you notice water flow issues in the RV, that might be a sign that the filter is clogged and needs replacing.

When not in use, the water filter cartridge should be stored out of freezing temperatures. RV antifreeze will damage the water filter cartridge. Filter locations will vary by model. They are typically located in a basement compartment behind the utility center (if equipped).

Each new RV is winterized with RV antifreeze before it is shipped to the dealer. To use the water purification system, system canister water lines need to be flushed of antifreeze and then the filter installed in the canister before use.



To Replace Canister Filter Cartridge

1. Turn off the water to the RV, and unhook the water line from the RV. The water pump should be off.
2. Place a drip pan below the filter housing to catch any spillage.
3. Using the provided filter wrench (typically found in the Customer Information Packet) to rotate the filter housing, unscrew the housing completely, dump any water out, and remove the filter (dispose of the old filter properly).
4. Clean the inside of the filter housing with mild detergent. Thoroughly rinse and wipe clean.
5. Remove the O-ring from the groove in the housing and wipe clean. Coat with petroleum jelly.
6. Replace the O-ring in the groove, making sure it is properly seated.
7. Install the new filter cartridge.
8. Replace the canister housing (hand tight is normally sufficient).
9. Turn on the water supply, turn the pump ON, open a faucet, and check for leaks. Turn the pump OFF afterwards.



Filter Wrench

NOTE

There is no bypass feature on a canister style water filter. The water filter must be removed from the filter housing before sanitizing or winterizing the RV.

Refer to the manufacturer's owner's manual and the label on the water filter cartridge for further information.

SPRAY PORT (IF EQUIPPED)

Your RV may include a spray port on the exterior of the trailer. This spray port provides a way to rinse off items outside the RV. There are no faucets to control (cold only) water flow. Water flow is controlled by the pump if dry camping or city water if using pressurized water. There is a removable spray nozzle at the end of the coiled hose. The hose is typically stored under the bed.



Using the Spray Port

Connect the end of the coiled hose into the fitting on the spray port. It has a collar on the fitting which operates similar to an air hose fitting. Pull back the collar on the spray port fitting, insert the end of the hose into the collar and release. The hose locks into the fitting. With the water supply turned on, pull the trigger on the spray nozzle until you have the desired water flow.

DO NOT USE THIS AS A POTABLE WATER SOURCE.

TOILET

⚠ CAUTION ⚠ (See page 79)

Your RV toilet has a flush pedal near the base on the front or side that when fully pressed sprays water into the bowl and opens a ball valve at the bottom of the bowl to flush waste directly into the black tank below it. The black tank only holds waste from the toilet.

Pressing the foot pedal halfway down will not open the ball valve, allowing you to fill the bowl with water. It is recommended to keep the bowl filled with at least 2" of water to help keep the ball valve seal lubricated and to act as an additional vapor barrier to the black tank.



Pre-use Setup

Prior to using the toilet for the first time at a campsite, it is important to add water to your black tank to help break down future solids. Add no more than 5 gallons of water at this time. This is also an appropriate time to add RV black tank treatments that help with odor and break down waste. Follow the directions from the treatment supplier.

Cleaning and Maintenance

The toilet should be cleaned regularly for maximum sanitation and operational efficiency.

Only septic safe toilet paper should be used.

Black tank levels can be inspected visually by pressing the toilet foot pedal down fully and shining a flashlight through the waste gate opening. The black tank should be flushed if it is near 3/4 full. See "Dumping the Tanks" on page 72 for more information.

DRAINING THE FRESH WATER SYSTEM

Fresh water tanks may be drained through a valve located near the tank. An RV with a demand pressure pump system will have low-point drains attached to the water lines (normally located near the water tank).

These low-point drains will release water in the supply lines by opening the valves and all faucets. The water heater has its own drain plug. To drain the permanent fresh water holding tank and supply lines:

1. Make sure the RV is level.
2. Disconnect the water line from the City Water connector on the RV (if connected).
3. Turn the water heater power OFF (turn off the electric and LP gas switches).
4. Open all faucets, including the outside shower faucet (if equipped)
5. Open the "fresh tank drain" valve. Depending on the model, fresh water tanks can be drained by one of the following methods:
 - A white plastic drain attached to the exterior wall, beneath the skirting.
 - Pull the white "T" handle on the fresh water holding tank to drain the water (Located near black and grey tank "T" handles).
6. Low point drains are installed at the lowest point of the water lines. A label is placed on the outside of the RV to indicate where the drains are located. Open the "low point drains" by turning the valves on the water lines (coming out from the underbelly).
7. Turn ON the water pump and allow it to run as needed.
8. Operate the toilet flush lever until water stops flowing.
9. If the RV water heater has bypass valves, set them to the BYPASS configuration (refer to "Tank Versus On Demand Water Heaters" on page 75).
10. Relieve the water pressure using the T&P (temperature and pressure) relief valve on the water heater by lifting the valve lever BEFORE removing the water heater drain plug. If the water heater was on beforehand, any water coming from the valve may be hot, so use caution. If pressure is not relieved, the water will spray out when the drain plug is removed. Once pressure is released, remove the drain plug.



Exterior Fresh Water Drain Example



Low Point Drain Example

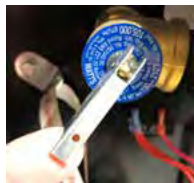

T&P Relief Valve Example

It is normal for some liquid to remain in the fresh water tank after drainage procedure. When you are finished draining the fresh water system, reverse these steps, and dump the grey and black water holding tanks at an appropriate facility or according to local public codes.

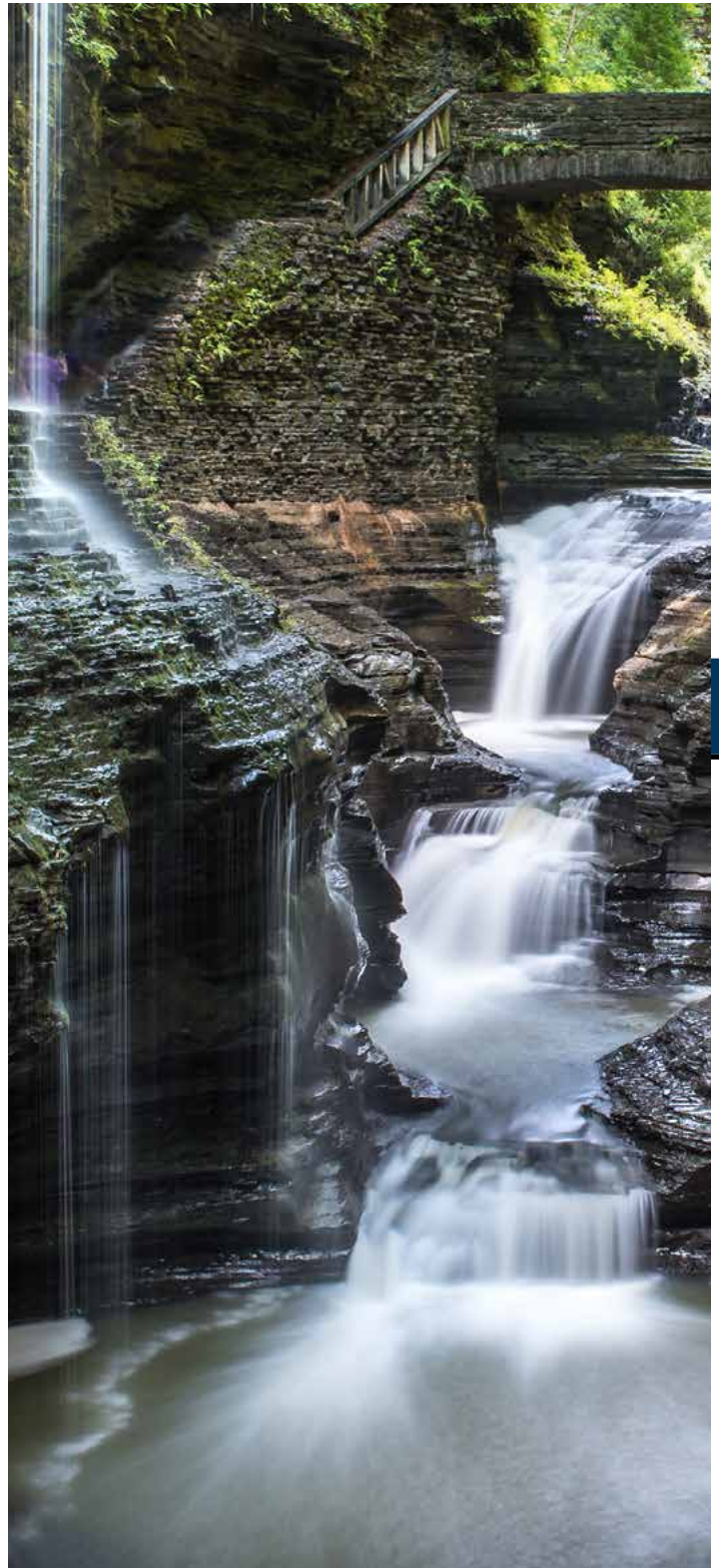

"We don't feel rushed to see everything all at once, allowing us to take more time to soak up our surroundings and be in the moment as a family."

Bill & Nancy
[New York]

PLUMBING SYSTEM

UTILITY CENTERS

Your RV may have one of a number of Utility Centers installed. Below is a list of Utility Centers in use along with the handle settings and links to further information on use, winterizing, and sanitizing.

Nautilus P1

www.bandbmolders.com/index.php/p1/



<p>Dry Camping Water from tank via pump</p>		<p>City Water City inlet to fixtures</p>		<p>Winterize Siphon to fixtures via pump</p>
<p>PowerFill TANK City inlet to tank</p>				<p>Sanitize Siphon to tank via pump</p>



Nautilus P2

www.bandbmolders.com/index.php/p2/





<p>City Fill</p>		<p>Tank Fill</p>	
<p>Winterize</p>		<p>Dry Camping</p>	



Nautilus P2.5

www.bandbmolders.com/index.php/p2-5/



<p>Sanitize</p>		<p>Dry Camp</p>	<p>Tank Fill</p>	
<p>Winterize</p>			<p>City Water</p>	

Nautilus P3

www.bandbmolders.com/index.php/p3-2/



<p>Dry Camping Water from tank via pump</p>		<p>City Water City inlet to fixtures</p>		<p>Winterize Siphon to fixtures via pump</p>
<p>PowerFill TANK City inlet to tank</p>				<p>Sanitize Siphon to tank via pump</p>



Nautilus P4

www.bandbmolders.com/index.php/p4/



<p>Dry Camping Water from tank via pump</p>		<p>City Water City inlet to fixtures</p>		<p>Winterize Siphon to fixtures via pump</p>
<p>PowerFill TANK City inlet to tank</p>				<p>Sanitize Siphon to tank via pump</p>



PLUMBING SYSTEM

Nautilus P4 - 3 Handle

www.bandbmolders.com/index.php/p4-3-handle/





<p>Dry Camping Water from tank via pump</p>		<p>City Water City inlet to fixtures</p>		<p>Winterize Siphon to fixtures via pump</p>
<p>PowerFill TANK City inlet to tank</p>		<p>Sanitize Siphon to tank via pump</p>		

Starcraft / Highland Ridge Basic Utility Center

www.bandbmolders.com/index.php/product/docking-station-city-fill-tank-fill-tank-flush-no-coax-key-lock/



<p>Tank Fill</p> 	<p>City Fill</p> 	
<p>The lever controls whether the pressurized water entering the fresh water connection inlet provides water directly to the fixtures in the RV (City Fill), or simply fills the water tank (Tank Fill).</p>		

Highland Ridge Fifth Wheel Utility Center

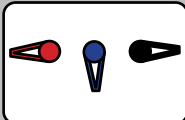
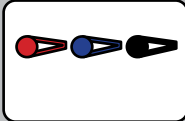
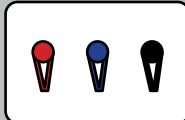
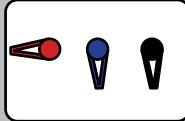
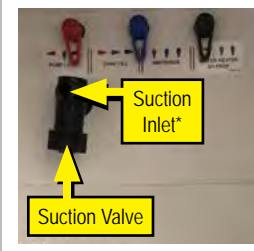

<p>Pump/City</p> 	<p>Tank Fill</p> 	<p>Winterize</p> 	<p>Water Heater Bypass</p> 	

*Turning on the water pump not only draws water from the fresh water tank for use in the RV fixtures, but it also enables pumping into the water system via a hose attached to the suction inlet. This can be used for pulling in fresh water from a container using the "Tank Fill" settings (for when pressurized water is not available to fill from the fresh water connection), pulling RV antifreeze in the plumbing lines using the "Winterize" setting, or for pulling an anti-bacterial solution into the system for line and tank cleanings us the "Tank Fill" setting.



WATER HEATER

⚠ WARNING ⚠ (See page 78)

Your RV may be equipped with either a tank water heater or on demand water heater. Not all on demand water heaters are completely tankless, instead using a very small tank to keep a pre-heated water reserve.



Gas/Electric DSI Tank Water Heater System (if equipped)

Make sure the water heater is filled with water before use as even momentary operation of the water heater without water in it may result in damage to the tank and/or controls. Always open both the hot and cold water faucets when filling the fresh water tank to allow air pockets to be forced out of the water heater.

The water heater does not have a pilot. It is equipped with a direct spark ignition (DSI) device which automatically lights the burner. Do not try to light the burner by hand.

Operating instructions

1. Turn ON the propane supply.
2. Turn ON electrical power to the water heater.
3. Turn the switch to the "ON" position. If the burner does not light, the system will automatically attempt two more tries for ignition before lock-out occurs. Each ignition cycle will have a 15 second purge before spark cycle if the system is a three try system.
4. If lock-out occurs before the main burner lights, turn the water heater control switch to OFF, wait five seconds and turn the switch to the ON position. This will restart the ignition cycle.
5. The first start-up of the heater may require several ignition cycles before all the air is purged from the propane lines.

If the burner will not come on, the following items should be checked before calling a service person:

1. See if the switch is turned OFF.
2. Make sure the propane supply to the water heater is not empty or turned OFF.
3. Check to see if the reset button on the water heater ECO is tripped.

Water Heater Switch (if equipped)

The "propane GAS" switch enables propane operation of the water heater, and the "ELECTRIC" switch enables electric operation.

NOTE

Water heaters in some models will ONLY have a single LP Gas water heater switch. These units will not heat water electrically.

Water Heater Bypass (if equipped)

Your RV may be equipped with a water heater bypass. This valve system is located at either the water heater, or on the utility center panel depending on your model. For detailed information refer to the "UTILITY CENTERS" on page 66 or "SANITIZING/WINTERIZING THE PLUMBING SYSTEM" on page 75.

Odor from the hot water system

Many water supplies contain sufficient amounts of sulfur to produce an odor, often called "sulfur water". Sulfur water can be caused by a chemical action or by bacteria. Generally, sulfur water is not harmful, only unpleasant to smell. Refer to the water heater manufacturer's manual for details on eliminating the odor from sulfur water. Odor from sulfur water is not a service problem.

High elevation deration

Operation of the water heater at high elevations may require derating. If the water heater is not properly derated, lack of sufficient oxygen for combustion may produce improper burner operation. Pilot outage caused by burner lift-off or sooting from a yellow burner may occur, indicating the possibility of carbon monoxide. You may also notice a lack of efficiency in heating the water because of incomplete combustion of the burner at these higher elevations. Consult with your dealer for proper derating of the water heater. Changing out of the orifice (derating) should be done by the dealer or a qualified service agency.

NOTE

It is important that once the RV has returned to lower elevation (below 4500 feet) any high altitude deration or other adjustments be reversed for proper operation of the water heater.

P&T Valve

⚠ WARNING ⚠ (See page 78)

The pressure and temperature (P&T) relief valve is designed to open if the temperature or pressure of the water is too high. When this happens, the pressure relief valve will open and water will drip from the valve. This "weeping" or dripping will continue until the pressure is reduced, and the valve closes. This condition is normal and does not indicate a defective relief valve.

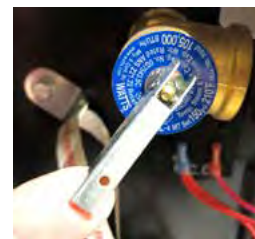

Water Heater Pressure Valve

One way to reduce the frequency of this occurrence is to maintain an air pocket at the top of the water heater tank. This air pocket will form in the tank by design; however, it will be reduced over time by the everyday use of your water heater. To replenish this air pocket:

1. Turn off the water heater.
2. Turn off the cold water supply line.
3. Open a faucet in the RV.
4. Pull out the handle of the P&T valve and allow water to flow from the valve until it stops.
5. Release the handle on the P&T valve - it should snap closed.

Close the faucet and turn on the cold water supply. As the tank fills, the air pocket will develop. Repeat this procedure as often as needed to reduce the frequency of the weeping P&T valve.

Maintenance

Do not allow the burner to burn with a yellow flame, or continue to operate the water heater with an improper burner flame. Periodically, inspect the water heater vent for soot. Soot is a sign of incomplete

PLUMBING SYSTEM

combustion and must be corrected before operating the water heater. This is your visual warning that the water heater is operating in an unsafe manner. If soot is present, immediately shut the unit down and contact your dealer or a qualified service agency.

Periodically inspect the vent for obstructions. Do not terminate the vent on your water heater inside of add-on rooms, screen porches or patios. Doing so will result in products of combustion being vented into the rooms or occupied areas.

Draining and Winterization

If the RV is to be stored over the winter months, the water heater must be drained to prevent damage from freezing. Damage to the water heater caused by freezing is not warrantable. For detailed information see "SANITIZING/WINTERIZING THE PLUMBING SYSTEM" on page 75.

ON DEMAND WATER HEATER (IF EQUIPPED)

⚠ WARNING ⚠ **⚠ CAUTION ⚠** (See page 78 & page 79)

The on demand water heater uses less LP gas than storage tank model water heaters since it only uses energy when hot water is demanded. There is no pilot light to burn when no hot water is needed. The on demand water heater supplies an unlimited supply of hot water on demand (once lines are purged of standing water). As hot water is used, the cold water enters the heater. A water flow sensor detects the flowing water and automatically ignites the burner. Water circulates through the heat exchanger and is heated to the set temperature. When the tap is closed, the unit shuts down.

The on demand water heater does not require an anode rod to prevent corrosion, or a by-pass valve for winterizing. It is not affected by high altitudes.

The output temperature of the water depends on the temperature of the inlet water AND the amount of hot water that is drawn. If the inlet water temperature is over 65° F, the tankless water heater will generate water in the range of 105° F to 120° F (on low flame) depending on the water flow selected by the user.

Filling the water heater

1. Close the water heater bypass lines (if equipped).
2. Turn on the fresh water supply or switch on the water pump.
3. Fill the plumbing system. Open all faucets, showers, toilet to bleed air from the lines.
4. When water flows out of the faucets, the system is vented.
5. Close all fixtures.

Operating Information

Open the exterior water heater panel to access the controls to able to turn the on demand water heater on and off, and set the water heater running mode. Depending on the model, settings may include:

- **ECO:** System is kept at a lower temperature and ramps up to full heat.
- **Basic/Comfort:** System stays at full temperature offering instant heated water.

For full details regarding the on demand water heaters' operation, maintenance, draining, and safety guidelines refer to the manufacturer's user guide in your Customer Information Packet, contact customer service or your dealer, or reference documentation available on the manufacturer's website.

Furrion	support.lci1.com/waterheater
Girard	support.lci1.com/gp-llc-other-products
Suburban	suburbanrv.com/service-support
Truma	truma.net/water-systems

Winterization

Freezing of the water heater and its plumbing components will result in severe damage not covered by warranty. At the start of the winter season or before traveling to a location where freezing conditions are likely, the unit must be winterized. For more information see "SANITIZING/WINTERIZING THE PLUMBING SYSTEM" on page 75.



PLUMBING SYSTEM

FAUCETS

The bathroom, kitchen and outside shower faucets operate much the same way as the faucets in your home.

NOTE

There may be air in the water plumbing lines which needs to be bled out before a steady stream of water comes from the faucet.

BATHROOM TUB / SHOWER

⚠ WARNING ⚠ (See page 78)

Keep the holding tank capacities in mind when using the fresh water system. The used water will drain into the grey water holding tank.

- Be sure the water heater is ON and had sufficient time to heat the water.
- If dry camping, be sure your 12-volt water pump is ON.

Unlike your home, the RV does not contain a water pressure balance valve. If someone is using the shower, it is recommended that the fresh water system **NOT BE USED** until they are finished.



The shower faucet may include a vacuum breaker (backflow preventer) for the shower. There are two purposes for this breaker:

- To prevent siphoning water back through the hose.
- To prevent water from being retained in the hose.

The shower head **DOES NOT** have a complete shut-off valve (the complete shut-off is at the hot/cold control(s)). The shower head may drip slightly in the OFF position; this is normal and does not indicate a leak or defect.

OUTSIDE SHOWER (IF EQUIPPED)

A handheld shower assembly with both hot and cold water may be included for use outside of your RV. It may be located in a separate outside shower compartment or at the utility center (if equipped).

1. Be sure the water heater is ON and had sufficient time to heat the water.
2. If dry camping, be sure the 12-volt water pump is ON.
3. Open the cover on the outside shower or utility center.
4. Remove the handheld shower from its holder.
5. Turn ON the hot and cold faucet knobs, and adjust the water temperature as desired.
6. To activate the handheld shower turn ON the sprayer head attachment (some models).



To turn off the water, always close the hot/cold control (faucet) knobs. The lever on the shower head will not completely stop the flow of water (this is intentional to allow for draining).

After the water has been allowed to drain from the shower head, return it to the outside shower storage. Any remaining water in the shower hose will drip or run out; this is not a leak but performs as intended. If you are dry camping, turn the water pump OFF.

Turning off the water with the shower head lever can also create a condition where the hot and cold water will mix through the outside shower faucet, thereby reducing the temperature of the hot water and give the appearance that the hot water heater is not working properly.

NOTE

The shower head may be removed from the hose so that it will drain faster. If you remove the shower head, be sure to reassemble it prior to storage.

When putting the shower assembly back into the storage compartment, make sure the hose is not pinched or the shower head is positioned in a way it can be damaged.

Some utility centers use a quick connect hose for outdoor shower operation. For more information see "UTILITY CENTERS" on page 66.

BLACK/GREY WATER SYSTEM AND TANKS

Water from the sinks and shower flows into the gray water (or wastewater) holding tank. Water from the toilet will flow into the black water (or sewage) holding tank.

P-Traps (if equipped)

The drain pipes may be equipped with a "P-trap" installed to help prevent odors from escaping into the RV. During travel, water from the P-traps may spill and permit odors into the RV. By adding water and using an RV approved deodorizing agent you will dissolve the contents faster and will keep the drain lines and tanks clean and free flowing. These chemicals are available at an RV supply store or your dealer.



Waterless Traps (if equipped)

Your RV may be equipped with a waterless trap that prevents the escape of odors from your waste system and eliminates the need for water-filled P-traps.



Should the RV drain piping system become clogged, it is important that the waterless trap be removed before passing a mechanical clean out tool through the piping to open the drain. Passing a clean out tool through the waterless trap may cause damage to the internal seal that may potentially allow sewer gases to escape into the RV interior. The waterless trap can be unscrewed from the water lines. A label has been placed near the location of the waste valve that reads as follows:

**REMOVE WATERLESS TRAP BEFORE
USING MECHANICAL DRAIN CLEANING
DEVICES**

Sewer Hose Storage

Depending on your RV model there are different locations for sewer drain hose (customer supplied) storage.

- Exterior compartment marked "SEWER HOSE"
- Hollow square tube bumper. The bumper has removable plastic end caps, and the hose slides inside the hollow bumper.
- PVC storage tube mounted under the frame.

Vents

Vent pipes and vents release air from the grey and black water holding tanks. On most models the exterior vent cap is attached to the roof and must be kept clear of obstructions to perform as intended. On some models, the vent pipe may be part of the drainage system referred to as a "wet vent" where water flows downward as air flows upward in the same pipe.

Some models are equipped with a side vent system. On these models this label will be next to the termination valve. This label should not be removed from your RV.

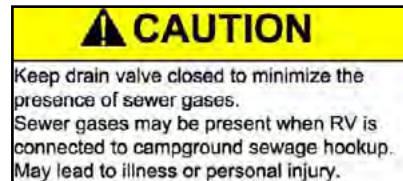

7.4.7.1.2

Black/Grey Water Holding Tanks

⚠ WARNING ⚠ **⚠ CAUTION ⚠** (See page 78 & page 79)

Dump the gray and black water holding tanks before traveling to avoid carrying unnecessary weight. The weight of the holding tank contents is not calculated into the RV cargo carrying capacity. Traveling with full holding tank(s) could cause you to exceed the individual tire ratings and/or the RV GAWR or RV GVWR. Potential damage to suspension components, such as springs, tires and axles, could result.



If you are dry camping and cannot immediately empty your holding tanks, reduce your vehicle speed until you reach a dumping station. When connected to the sewer drain line at a campground, keep the black tank drain valve closed until the holding tank is at least 3/4 full. This will provide sufficient water to assist in complete draining of the black water holding tank. Repeat as needed.

Before using the RV, or after dumping the grey and black water holding tanks, always add the proper amount of black tank treatment to the black water tank to prevent odors and help break down holding tank contents (unless winterizing). Follow the treatment bottle or package instructions. Driving to a disposal site will normally loosen any accumulated waste debris or solids from the sides of the holding tanks.

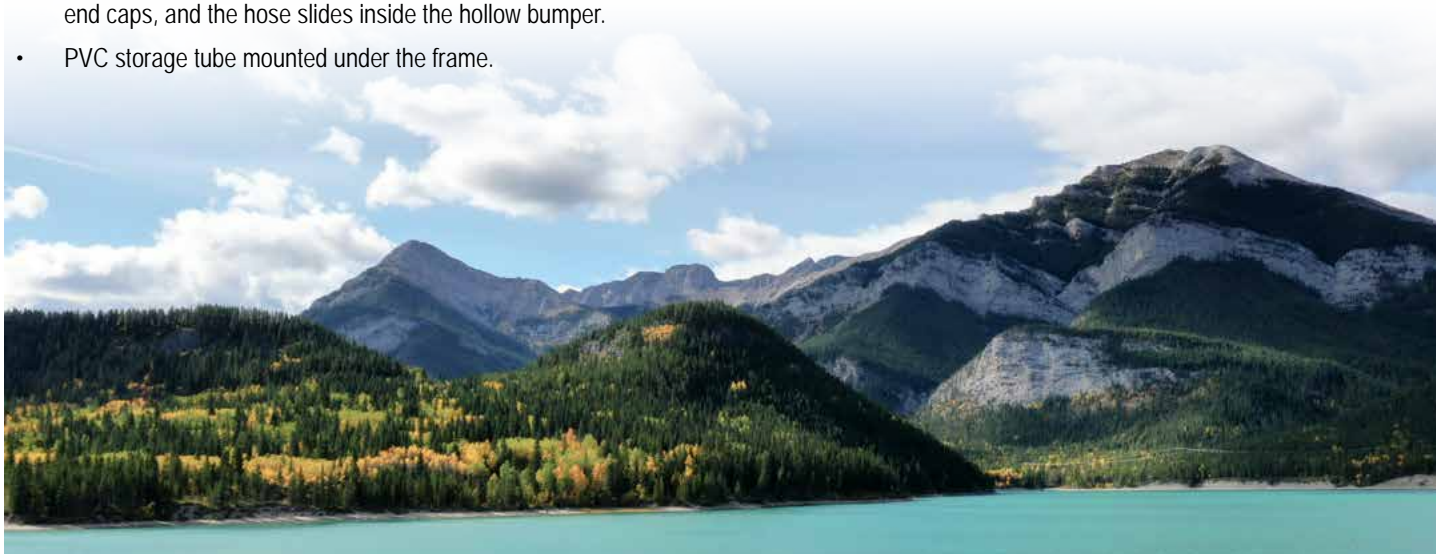

PLUMBING SYSTEM

BLACK AND GREY TANK DRAINS

There are labels on the exterior of the RV indicating the location of the grey and black tank drains (also called dump valves). Depending on your model, you may have one or two valves. With one valve, the gray and black tank will release contents simultaneously. With the 2-valve set up, it is recommended that you release the black tank first, followed by the grey tank. This will help rinse any debris from the outlet and sewer hose.



Example of Tank Drain Located Underneath RV

Dumping the Tanks

1. To make drainage easier, make sure the RV is level.
2. Remove the waste pipe cap by rotating it counter-clockwise until the locking teeth disengage, and pull to release.
3. Attach the sewer hose (customer supplied) by pushing the RV end onto the RV waste pipe and rotating clockwise until the locking teeth fully engage.
4. Secure the other end of the sewer hose into the approved dump location.
5. Open the black tank dump valve (depending on your model the valve may be located under the RV, or in the utility center). Close the dump valve when the black water holding tank is empty.
6. Open the grey tank dump valve (depending on your model the valve may be located under the RV or on the utility center). Close the dump valve when the grey holding tank is empty.
7. Ensure that everything has drained from the hose into the sewer.
8. Remove and store the sewer hose.
9. Re-attach the waste pipe cap reversing the process from step 2.

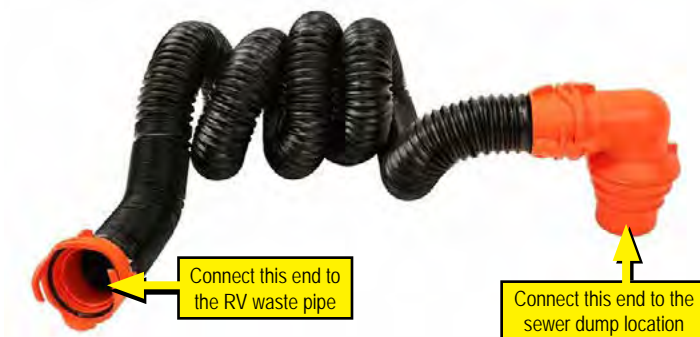

Sewer Hose Example

It is always a good idea to check with your campsite in advance to make sure what kind of dumping stations are available. Dump sites can sometimes, but not always, be found at campgrounds, state parks, truck stops, and some larger sporting good chains that focus on camping. Sanidumps.com is a comprehensive RV dump station search site that can help you plan for your next trip.

Contact your RV dealer for assistance in the purchase and installation of a sewer hose or sewer hose extension (if needed).

Sewage (black) tank preparation

It is important to add water to your black tank to help break down future solids. Add no more than 5 gallons of water at this time by either pouring in water or holding down the flush pedal on the toilet. This is also an appropriate time to add RV black tank treatments that help with odor and break down waste. Follow the directions from the treatment supplier.

Waste (grey) holding tank preparation

No special preparation is required, however, placing a small quantity of chemicals into this tank, such as baking soda or an approved RV chemical, will reduce odors from food particles in the system.



MACERATOR PUMP SYSTEM (IF EQUIPPED)

⚠ WARNING ⚠ **⚠ CAUTION ⚠** (See page 78 & page 79)

Your RV may be equipped with a macerator pump system used to discharge waste from the gray and black waste tank. The system has a 1-1/2 inch diameter flexible hose that runs from the pump (under the RV) and is stored in an exterior storage compartment. The system, when powered on, can discharge waste (uphill if necessary) up to a distance of 150 feet.



Garden Hose Connection

Open the hose compartment and pull out the 1-1/2 inch flexible hose with the attached dump connector. The dump connector includes two connections: a small removable cap for attaching a 3/4 inch garden hose, and a larger 3-inch removable cap that allows it to attach to the sewer outlet at the dump station.



Dump Station Connection

Using the system:

1. To make drainage easier, make sure the RV is level.
2. Attach the dump connector to the 3-inch sewer outlet at the dump station, or to a 3/4-inch garden hose and run the hose to a dumping location.
3. Open the black tank dump valve.
4. Turn the Macerator power switch ON (switch lights up red) at the hose storage compartment and the macerator pump will begin sending waste through the dump hose.
5. When the tank is empty, turn the macerator power switch OFF.
6. Close the black tank valve.
7. Open the gray tank dump valve.
8. Turn the Macerator Power Switch ON.
9. When tank is empty, turn the macerator power switch OFF.
10. Close the gray tank valve.
11. Unhook the dump connector, rinse it out and place the hose and connector back into the storage compartment.

Macerator Bypass Valve

The Macerator Bypass Valve is located underneath the external hose storage box. This bypass will allow you to gravity dump the waste from the tanks straight down to a 3-inch sewer hose connection under the trailer in the event there is a problem with the macerator motor.

NOTE

The bypass valve also doubles as an emergency cutoff in the event of a problem with the flex hose or dump connector. Closing the valve stops waste flow out of the macerator pump and up to the flex hose, but will divert waste to the main dump connector under the RV. Make sure the main dump gate valve is closed until you are ready to empty the black tanks.

To operate:

1. Attach a 3-inch sewer hose to the main dump connector under the trailer and to a sewer outlet at a dump station.
2. Open the desired black / gray (manual) drain valves, one at a time (black then gray).
3. The bypass valve is normally open (handle is pulled OUT). To bypass the macerator, push the bypass valve IN (turns off flow from the macerator pump) allowing waste to flow out of the dump connector under the trailer via gravity.

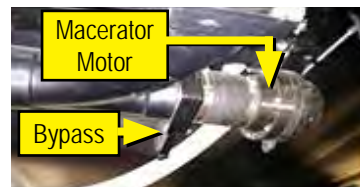

NOTE

The bypass valve for the macerator is typically pointing back underneath the coach. Handle position is normally pulled OUT (bypass closed). The valve position is by design, so it can't be activated accidentally when system is operating normally.

4. When finished, close the main dump gate valve under the trailer, along with the black / gray dump valves. Disconnect the sewer hose from the main dump connector and at the dump station.

Winterize the Macerator system

1. Ensure all waste tanks are empty.
2. Pour RV antifreeze into the toilet and down into the black water tank.
3. Make sure macerator bypass valve is pulled OUT. Turn the macerator pump ON.
4. Run the pump until antifreeze begins to discharge from the dump connector attached to the flex hose.

NOTE

Use a container (bucket) for capturing system fluid.

5. Turn the macerator pump OFF.
6. Drain the flex hose by holding it at a sloped angle to drain excess water and return the hose to the storage location.
7. As an added safety measure, push the Macerator Bypass valve IN to bypass the macerator and let it drain.
8. After draining make sure to pull the macerator bypass valve OUT again.

De-winterize the macerator system

Emptying the black tanks in the spring will flush antifreeze out of the macerator system.

PLUMBING SYSTEM

BLACK TANK FLUSH (IF EQUIPPED)

⚠ WARNING ⚠ **⚠ CAUTION ⚠** (See page 78 & page 79)

The black tank flush inlet is typically located either on the utility center panel (if equipped) labeled as "Tank Flush"; or on the side or back of the RV with a caution label next to it.

The black tank flush inlet is connected to a black water holding tank sprayer connection, allowing you to remove debris and prevent accumulation. A check valve is incorporated in the plumbing lines to prevent back flow. Flush the black water tank each time the grey and black holding tanks are dumped or as needed.



Exterior Black Tank Flush Inlet Example

NOTE

Utility center (if equipped) valve positions do not affect the tank flush function. It does not matter where they are positioned when operating the tank flush.

To help insure debris does not clog the tank sprayer orifices, use "TANK FLUSH" every time the waste holding tank is emptied.

1. Dump the black water tank (see "**BLACK AND GREY TANK DRAINS**" on page 72) and **LEAVE THE BLACK TANK DRAIN VALVE OPEN**.
2. Connect a garden hose from the water supply source to the black tank flush.
3. Turn the water source turned ON, flushing the black water holding tank until the water running out of the black tank drain valve is clear (not discolored or cloudy).
4. Turn off the water source, disconnect the garden hose, and close the black tank drain valve. Fasten the waste pipe cap back on the RV tank flush exit.

Winterize the Black Tank Flush

1. Black tank should be flushed and empty prior to winterizing.
2. Connect a blowout plug to the Black Tank Flush inlet.
3. Colored valves have no effect on the black tank flush inlet.
4. Connect the air hose from a compressor to the blowout plug. Set the compressor to 30 PSI maximum.
5. Open the black tank drain gate valve and remove the waste pipe cap.



Blowout Plug Example

NOTE

If the RV has a macerator system, you need to open the bypass valve for the macerator under the RV. This will allow the black tank to drain through the 4" sewer hose.

6. Blow air into the flush inlet for 30 to 60 seconds.
7. Disconnect the air hose, compressor and blowout plug.
8. Close the black tank drain gate valve, install the waste pipe cap, and close the macerator bypass valve (if applicable).

TANK HEATERS (IF EQUIPPED)

⚠ CAUTION ⚠ (See page 79)

Your RV may be equipped with heaters for the fresh, gray, black water tanks, and the water lines or drain lines. These heaters will prevent water in the tanks and lines from freezing down to -11°F (-24°C) (contingent on RV setup).

The larger tank heaters are 120VAC and attach directly to the tanks. The thermostat controlled tank heaters will cycle on at 44°F (7°C) and off at 64°F (18°C). Water line or drain line heaters are smaller and operate on +12VDC and will be attached to the water lines or drain lines. The +12VDC heaters stay on constantly.

All of the heaters are controlled by a single ON/OFF switch that is typically located on the command center panel or in the bathroom. The switch lights up red when ON and controls the heater circuit.

The tank heater switch should be turned ON:

- When liquid is present in the holding tanks and the outside temperature approaches and maintains freezing conditions 35°F (2°C) or colder.

The tank heater switch should be turned OFF:

- When there is NO liquid present (tanks are empty).
- When dumping the black and gray holding tanks and the drain pipes.
- When fresh water tank and supply lines are empty or being drained for storage.
- When the RV is connected to city sewer and the gate valves are open.

NOTE

Leaving the drain valves open at all times while camping is never recommended, especially in cold weather use.

- When ambient temperatures rise and remain above freezing.

No maintenance on the heaters is required, only a periodic inspection for loose wires, damage, etc. For additional detailed information, refer to the tank heater manufacturer's user guide.



SANITIZING/WINTERIZING THE PLUMBING SYSTEM

Tank Versus On Demand Water Heaters

When winterizing and sanitizing it is important to keep bleach solutions and anti-freeze out of your hot water tank. For this reason, systems with a tank water heater have an added bypass line that allows the solutions to never enter the tank. The bypass line and associated valves are found at the water heater.

- **Normal Mode:** allows water to flow into the water heater. Both hot and cold bypass valve handles should be pointed toward the water heater connections.
- **Bypass Mode:** diverts the flow of water around the water heater keeping water out of the water heater. Hot water bypass valve handle (C) should point inline with the hot water outlet line. Cold water bypass valve handle (B) should point inline with the cold water inlet line.

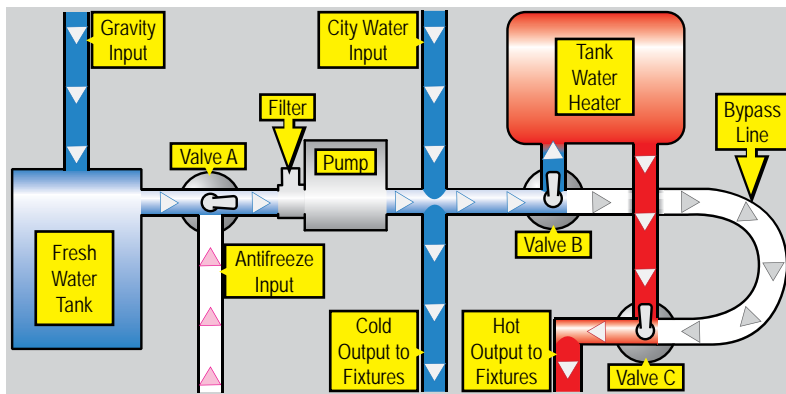

2-Valve Tank Water Heater Bypass - Valves Shown in Normal Mode

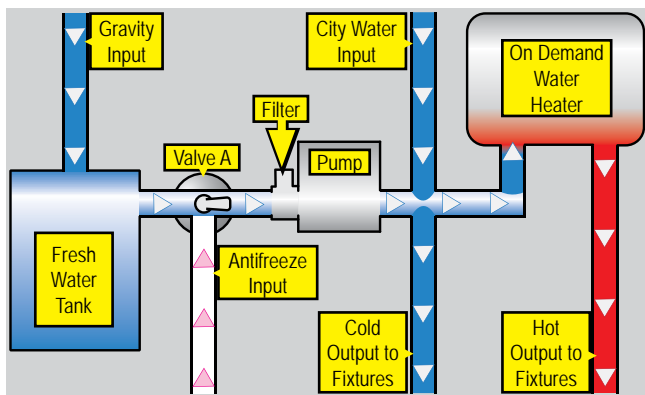

On Demand Water Heater System - Valve Shown in Normal Mode

Units with on demand water heaters do not have the bypass line, as it is acceptable to pass sanitizer and antifreeze through these systems. However the water heater should always be turned off when doing so.

Antifreeze Siphon

With both tank and on demand water heater systems there is an additional line and valve (A) added just before the water pump that allows you to use the water pump to siphon antifreeze into the fresh water system, skipping the fresh water tank. Turning Valve A towards the siphon line changes the input flow from the fresh water tank to the siphon line.

Utility Centers

If your RV has a Utility Center, please refer to "UTILITY CENTERS" on page 66 for special instructions specific to the installed Utility Center in regards to sanitizing/winterizing.

Sanitizing the Plumbing System

Sanitize your fresh water system:

- When your RV is new.
- At the beginning and end of each season.
- When the water system becomes contaminated or every three months of use.

Preparing to sanitize

Prepare a chlorine solution using 1/4 cup of household bleach to one gallon (3.785 liters) of water in a container. Prepare one gallon of solution for every 15 gallons of tank capacity. This will result in a residual chlorine concentration of 50 ppm in the water system and should remain in system for at least 4 hours.

If a 100 ppm concentration is needed, use 1/2 cup of household bleach with one gallon of water. One gallon of the solution should be used for each 15 gallons of tank capacity. Allow to remain in system for at least 1 hour.

NOTE

Fresh water tank sizes vary by model. Contact your dealer or customer service for your specific tank size.

How to sanitize

1. Turn water heater OFF (both electric and LP gas switches if applicable).
2. Set the bypass valves to the **BYPASS** position for tank water heater systems.
3. Level the RV and drain the fresh water system (see "**DRAINING THE FRESH WATER SYSTEM**" on page 65).
4. Close the low point drain valves, the fresh water tank drain valve, and reinstall the water heater drain plug.
5. If the RV has a cartridge type water filter, the filter must be removed from the housing. Sanitizer should never be allowed into a water filter.
6. Pour the sanitizer solution in the fresh water tank using the gravity fill inlet. **Do not use your non-toxic drinking water hose.**
7. Continue filling the fresh water tank with clean (potable) water until tank is full.
8. Turn the water pump on to send water through the lines. Open all hot water faucets one by one until water begins to flow continuously and a chlorine smell is noticeable. Include outside shower faucets (if equipped).

PLUMBING SYSTEM

9. Close the hot water faucets and repeat opening all cold water faucets one by one until you smell chlorine. Include outside shower faucets (if equipped) and toilet.
10. Turn OFF the water pump.
11. Let the solution remain in the tank and lines for at least four hours when disinfecting with 50-PPM residual chlorine, and for at least one hour if using a 100-PPM chlorine concentration.
12. After the required period, drain the chlorine solution from the fresh water system. Since the tank water heater was bypassed there should be no sanitizer in the water heater tank.

NOTE

It is possible to sanitize the fresh water system with a 50/50 solution of white vinegar and water instead of a bleach solution. However, for the vinegar solution to work as a sanitizer, the temperature of the solution must be at least 130 degrees. Your RV water heater will not raise the temperature to this level, so the heated water will need to come from an outside source. Use caution when handling the heated solution if you decide to use this method.

A vinegar solution used to just clean and descale water systems does not need to be heated, and is safe to run through the system.

Rinse the system with fresh water:

13. Fill the fresh water tank full of clean (potable) water using the gravity fill inlet. Power to water heater should be OFF.
14. When the fresh water tank is full, turn the pump ON to send water through the lines. Tank water heater bypass valves should still be set to **BYPASS**.
15. Run water through all faucets (hot and cold, including outside shower) until chlorine smell is gone. For an on demand water heater, remove the drain plug and allow the water heater to rinse.
16. Turn OFF the faucets, outside shower, and pump. Re-install the water heater drain plug on your on demand water heater (if applicable).
17. Drain the fresh water system again.

If a chlorine taste lingers in the water, flush the water system with a solution consisting of one-quart vinegar to five gallons of clean water. Re-flush as necessary.

After Sanitizing:

- Set the Bypass valves to normal.
- Make sure all faucets are off including the external shower.
- Make sure the water heater drain plug is installed.
- Close the gravity fill inlet.
- Make sure the fresh water and low point drains are closed.
- Wash out the water filter housing and reinstall the water filter (if applicable).

Winterizing the Plumbing System

Preparing your RV for colder weather or storage is very important. Failure to prepare your RV may cause water supply lines and the water heater to freeze. The RV should be winterized at the end of the camping season or when it will be exposed to temperatures that will fall at or below 32°F (0°C). Repairs due to freezing are not covered by warranty.

NOTE

The winterization process may vary slightly due to different plumbing configurations between models. Appliances must be winterized. Refer to the manufacturer's manual for additional information or contact Customer Service for assistance.

If you chose to perform the winterization process yourself, read and understand the following information before starting. Contact customer service or your dealer for questions about this process. It may be easier to winterize the RV with another person to assist you.

Winterizing with Antifreeze Method (Preferred)

⚠ CAUTION ⚠ ⚠ WARNING ⚠ (See page 79)

Requires non-toxic RV antifreeze in the water lines and does not require any special tools. Use **ONLY RV ANTIFREEZE** in your fresh water system for freeze protection. No other product or commodity should be used.

NOTE

Antifreeze should never enter the tank water heater, RV water filter, refrigerator, refrigerator water filter, or fresh water tank.

1. Turn water heater OFF (both electric and LP gas switches if applicable).
2. Set the bypass valves to the **BYPASS** position for tank water heater systems.
3. Level the RV and drain the fresh water system (see **"DRAINING THE FRESH WATER SYSTEM"** on page 65).
4. Set the tank water heater bypass valves to **BYPASS**.
5. If the RV has a cartridge type water filter, the filter must be removed from the housing. Antifreeze should never be allowed into a water filter.
6. Close the fresh water tank and low point drains, and re-install the water heater drain plug if removed.
7. Open antifreeze siphon valve (A) at the water pump with the clear hose attached. Valve handle points toward the clear hose and insert the opposite end of the clear hose into a container of RV antifreeze solution.
8. Turn the water pump ON. Antifreeze will be drawn into the water lines. **In order to create a suction, all low point drains must be closed.**
9. Open the hot water faucets, including outside shower (if equipped) until RV antifreeze begins to flow continuously.
10. Close the hot water line faucets and outside shower and repeat with the cold water line faucets. Hold open the lever on the toilet until antifreeze runs into the bowl.

PLUMBING SYSTEM

When you are done adding RV antifreeze:

1. Turn the water pump OFF. Turn antifreeze siphon valve (A) to the normal position. Remove the clear hose from the container of RV antifreeze.
2. Pour 1 cup of RV antifreeze into each sink's drain P-trap.
3. To prevent staining, wipe the RV antifreeze out of the sinks, shower (or tub) and toilet using a soft, dry cloth.

In the spring after flushing antifreeze out of the water lines, wash out the water filter housing, and re-install the water filter (if applicable).

Air Pressure Method

⚠ WARNING ⚠ (See page 78)

This method uses compressed air to blow out any remaining water in the system after initially draining water using drain valves. Tools required would be an air compressor and a blowout plug.

1. Turn water heater OFF (both electric and LP gas switches if applicable). Allow the water in the water heater to cool before continuing. Periodically run a hot water faucet to check the temperature to be sure the water had cooled.
2. Level the RV and drain the fresh water system (see **"DRAINING THE FRESH WATER SYSTEM"** on page 65).
3. Tank water heater bypass should be set to **NORMAL**. This allows air to flow through the water heater. Remove the water heater drain plug. **DO NOT REMOVE THE DRAIN PLUG IF THE WATER HEATER IS HOT OR UNDER PRESSURE.** Release pressure using the pressure release valve and allow any stored water to cool.



Water Heater Pressure Valve

4. If the RV has a cartridge type water filter, the filter must be removed from the housing.
5. Run the pump until it is dry (approximately 15 to 20 seconds). Operating the pump longer than that with no water can damage the pump.
6. Open all faucets in the RV. If there is an outside shower, attach the shower hose to the shower, and open the shower faucets.
7. Attach a blowout plug to the city water inlet on the outside of the RV.
8. Attach the air hose to the blowout plug. Set compressor to 30 PSI.
9. Fresh water tank drain should be open.
10. Blow air into the water lines through the blowout plug and the City Water Inlet to evacuate all water from the lines.
11. Blow out the water lines, which can take 5 to 10 minutes.
12. Pour one cup of RV antifreeze into each of the drain P-traps (sinks and bathtub).
13. To prevent staining, wipe the RV antifreeze out of the sinks, shower (or tub) and toilet using a soft, dry cloth.
14. After RV water lines have been blown out, remove the air hose and the blowout plug from the City Water Inlet.



Blowout Plug Example

In the spring:

- Turn off all the faucets (inside and out).
- Reinstall the water filter (if applicable).
- Reinstall the water heater drain plug.
- Close all low point and fresh water drains.



**FRESH WATER SYSTEM (page 62)**

DO NOT drink water deemed microbiologically unsafe or of unknown quality.

The weight of holding tank contents is not calculated into the RV cargo carrying capacity. Traveling with full tanks could cause you to exceed the individual tire ratings and/or the RV GAWR or GVWR. Traveling with full tanks can also affect your vehicle handling characteristics.

WINTERIZING WITH THE ANTIFREEZE METHOD (page 76)

Automotive antifreeze (ethylene glycol) and windshield washer antifreeze (methanol) are poisonous. Never use these products in your fresh water system. These products are harmful and may be fatal if swallowed.

AIR PRESSURE METHOD (page 77)

Never apply air pressure to the water system with any of the valves in the closed position. Air pressure applied to a closed valve, faucet or low point drain could potentially damage the seals and cause water leaks. If you have questions, consult with your RV dealer. Using RV antifreeze is the preferred method of winterization.

Recommended pressure is 30 PSI. Exceeding this pressure may rupture water line couplings and void your warranty.

P&T VALVE (page 68)

Do not place a valve between the pressure and temperature (P&T) valve and the tank. Do not remove or plug the relief valve under any circumstances.

Valve is not serviceable; if defective it must be replaced.

Tampering with valve will result in scalding injury. Do not place a plug or reducing coupling on outlet part of valve. If you use a discharge line allow complete drainage for both valve and line.

Tampering with valve will void the warranty.

BATHROOM TUB/SHOWER (page 70)

Water temperatures over 125°F (49°C) can cause severe burns instantly, therefore be careful when using hot water. Always test the water temperature before showering or washing.

BLACK/GREY WATER HOLDING TANKS (page 71)

Never travel with full black or grey water holding tanks. Depending on the location of the tank(s) it can affect your tow vehicle handling characteristics.

BLACK TANK FLUSH (page 74)

Do not use the same hose to fill your fresh (potable) water tank that is used for the black tank flush.

WATER HEATER (page 68)

Hydrogen gas may result if you have not used the water heater for two weeks or more. **HYDROGEN GAS IS EXTREMELY FLAMMABLE.**

To reduce the risk of injury under these conditions, open the hot water faucet for several minutes at the kitchen sink before you use any electrical appliance connected to the hot water system. If hydrogen is present, you may hear what sounds like air escaping through the pipe as the water begins to flow. Hydrogen gas may be present even after water has been drained from the water heater tank. Open the faucet at the sink and allow the system to vent for five to ten minutes. Do not smoke or have any open flame near the open faucet while venting. On DSI water heater models, make sure the switch is OFF.

Do not alter the operation or change the design/construction of your water heater. For your safety, only factory authorized parts should be used on your water heater. Accessories marketed for recreation vehicles, such as an "add-on" electric heating elements, are not recommended by the manufacturer. Such items are not approved to be installed and could create an unsafe condition and will void all warranties.

If you smell propane gas then STOP! and follow the procedures listed in the Propane System Section before attempting to operate the water heater.

ON DEMAND WATER HEATER (page 69)

Danger of combustion, personal injury and damage to the RV!

Keep the area around the appliance free from combustible materials, gasoline and other flammable liquids or vapors.

Switch OFF the appliance and gas supply:

- If you smell gas
- If anything appears out of the ordinary
- If you move the RV
- Before entering a gas station
- Before entering a tunnel

Danger of over-temperature and toxic exhaust gases!

Use with LP gas (propane) only. Butane or any mixtures containing more than 10% butane must not be used.

Keep the air inlet and exhaust gas outlet free of obstructions. Do not lean any objects against the water heater access door or place any foreign objects within 2 feet (61cm) of the access door.

MACERATOR PUMP SYSTEM (page 73)

Before operating the macerator pump, make sure the external dump hose is properly attached at the RV and at the dump station. The hose is under pressure and therefore waste is discharged under pressure. Failure to follow instructions can lead to possible injury or property damage. The use of this system for anything other than intended will void the warranty.

CAUTION

WATER PRESSURE REGULATOR (page 62)

A water pressure regulator is recommended to prevent damage to the plumbing system or components. To prevent damage when using the city water connection, a 45 lb. (315 KPa) rated water pressure regulator is recommended.

FRESH WATER HOLDING TANK (page 62)

Do not cap, block or modify the fresh water tank overflow tubes in any way. Enough water pressure can build up during the filling process to damage the plumbing system if the overflow tubes are obstructed.

Be careful not to overfill the fresh water holding tank. It can pressurize the tank, causing leakage and water damage and void the warranty. DO NOT leave the tank unattended while filling.

WATER PURIFICATION SYSTEM (page 64)

Do not allow water in the canister housing to freeze.

Remove the filter before using anti-freeze to winterize the system or chlorine solution to sanitize the system.

Flush canister housing thoroughly before it is put back into service after winterizing or sanitizing.

For best results replace filter every 6-12 months.

Do not use carbon cartridges where water is microbiologically unsafe or of unknown quality.

Maximum operating pressure is 125 psi (8.75 bar).

Maximum water temperature is 125° F (52° C).

TOILET (page 64)

It is important to prevent solid waste buildup. Follow the toilet manufacturer's recommended instructions each time after emptying the black water holding tank.

To help prevent toilet blockage, always use RV grade single-ply toilet paper. Do not flush paper towels, diapers, sanitary napkins or other foreign objects down the toilet.

Do not use chlorine (undiluted) or caustic chemicals, such as laundry bleach or drain opening types, in the toilet system. These products damage the seals in toilets and dump valves.

WINTERIZING WITH THE ANTIFREEZE METHOD (page 76)

Water can accumulate in the flexible hose and dump connector of the macerator system. When winterizing the RV, antifreeze must be added to the macerator system.

ON DEMAND WATER HEATER (page 69)

Water in pipes, faucets and appliances could freeze. Considerable damage may result.

Before you fill water into appliances and parts that transport water, you must heat the installation area sufficiently so that water cannot freeze.

BLACK/GREY WATER HOLDING TANKS (page 71)

Never leave the black tank drain in the open position continuously when connected to the campground sewer system. Leaving the drain open will allow the liquid to drain out increasing the potential for a blockage in the tank. Keeping the drain in the closed position will prevent debris from accumulating in the tank.

Do not add automotive antifreeze or caustic chemicals, such as laundry detergents, into the holding tanks. Although these products may have a deodorizing effect, they may damage the plastic and rubber parts of the plumbing system or the components.

MACERATOR PUMP SYSTEM (page 73)

Water can accumulate in the flexible hose and dump connector of the macerator system. When winterizing the RV, antifreeze must be added to the macerator system.

BLACK TANK FLUSH (page 74)

The black tank drain valve must be OPEN any time there is a hose (water supply) connected to the black tank flush.

Do not leave any hose (water supply) connected to the black tank flush when it is not in use.

TANK HEATERS (page 74)

In order for the 120VAC tank heaters to be in operation, the recreation vehicle MUST be hooked up to shore power or under generator power.

If the recreation vehicle is not operating on shore power or generator power, only the +12VDC heaters will operate. This can result in the tanks freezing.

The red light on the command center tank switch does not necessarily indicate that ALL heaters are operating; it is only a warning that the heater circuit is ON.



SECTION 9: HEATING & COOLING



AIR CONDITIONER

RV air conditioners incrementally cool the interior air of the unit. The hotter the interior temperature, the longer it will take to cool the air down to a comfortable level. There are a few things you can do to help expedite the process:

- Park the RV in a shady area.
- Start the AC right away once the RV is setup.
- Close window shades/curtains to block heat from the sun.
- Keep doors and windows closed as much as possible.

NOTE

In warm, high humidity areas, when using air conditioning, run it on high to increase air flow and help keep moisture from condensing on the coils.

Make sure you have sufficient power available before operating the air conditioner.

Cooled air enters the RV through the grill. Do not operate the air conditioner without the return air filter. Operating the system without the filter allows the lint and dirt that is normally stopped by the filter to accumulate on the cooling coil of the air conditioner. This also will lead to a loss of air volume, possible equipment damage and an expensive cleaning process.

For instructions on air conditioner use and maintenance, refer to the manufacturer's user guide included in your Customer Information Packet.

Roof Mount (if equipped)

Roof mount air conditioners may be ducted (connected to other vents in the roof interior) or non-ducted. On ducted units, close the air vents on the main AC unit to force more air through the ducts, and achieve better air circulation throughout the RV.

A special foam gasket is placed between the roof material and the sub frame of the air conditioner to guard against water leakage. The air conditioner is subjected to wind pressures along with motor vibration during normal operation. Inspect the mounting bolts for tightness to ensure there is no leakage or looseness at least annually. Re-tighten bolts when they are loose. DO NOT over tighten these bolts as it may

damage this gasket. The air conditioner gasket is a wearable part that eventually will need to be replaced. To gain access to the bolts, remove the filtered panel cover on central air systems or the entire air box on non-central air conditioners.

Wall Mount (if equipped)

Keep the air inlet grill and cabinet clean by wiping with a cloth dampened with warm water and a mild detergent.

POWER ROOF VENT (IF EQUIPPED)

The 12-volt DC attic fan (or powered roof vent) allows fresh air to circulate through the recreational vehicle. Do not leave the attic fan open when the recreational vehicle is stored or unattended for long periods. High winds, other unusual conditions or obstructions may prevent the dome from closing. The resulting leakage could cause non-warrantable damage.

To use your fan most effectively, close all vents and slightly open a window on a shaded side of your recreation vehicle. You are directing the air flow by opening a window.

The roof vent may be controlled by either a control pad or touch screen (if equipped)

For additional safety and operating information, refer to the manufacturer's user guide included in your Customer Information Packet.

FIREPLACE (IF EQUIPPED)

Your recreational vehicle may include an electric fireplace insert. For detailed operating and safety information, refer to the manufacturer's user guide included in your Customer Information Packet.



CEILING FAN (IF EQUIPPED)

WARNING

Be careful to avoid placing any object in the path of the ceiling fan blades!

Turn the ceiling fan ON/OFF using a switch typically located on the wall, or in an overhead cabinet. The ceiling fan's 3 speeds are controlled by a pull chain switch. Pull chain settings are (in order): Off, High, Medium, Low. The slide switch (located on the fan) controls the direction of operation (down for forward, up for reverse). **Stop the fan first before using the direction switch!**

NOTE

During cooler temperatures, set your fan settings to "low," and set the fan to turn clockwise to create an updraft and help circulate warm air. In the summer, the fan should turn counterclockwise to create a down draft of cooling air.

For additional information refer to the manufacturer's owner's manual in the Customer Information Packet.

FURNACE

The furnace installed in your recreation vehicle is controlled by a 12-volt DC thermostat. Depending on your model, there may be up to two thermostats enabling you to control the temperature to your comfort level. The furnace requires both 12-volt power and propane gas for full operation. Make sure you have sufficient power available before operating your furnace.

A qualified RV technician should perform all furnace maintenance at least once a year (more often depending on furnace usage). Never attempt to repair the furnace yourself.

NOTE

For RV models with touch screens, the furnace controls may be included on the selectable menu screens of the touch screen and in the JayCommand/TravelLINK smartphone app.

WARNING

- The furnace should be inspected periodically (monthly during the heating season) for presence of soot on the vent. Soot is formed whenever combustion is incomplete. This is a visual warning that the furnace is operating in an unsafe manner. If soot is observed on the vent, immediately shut the furnace OFF and contact a qualified service agency. Operating the furnace under this condition could lead to serious property damage, personal injury or loss of life.
- To ensure your personal safety, do not obstruct or alter the furnace in any manner. Do not install screens over the vent for any reason. Screens will become restricted and cause unsafe furnace operation. For your safety, only the manufacturer's factory authorized parts should be used on your furnace.

Ducting & Return Air

All heat discharges, registers and return air grills must be free and clear of obstructions. This includes all closeable registers that are intended to reduce airflow, do not shut it off completely.

Heat pump operation (if equipped)

Set the thermostat for either electric or gas heat. On the electric setting, the heat pump will become the primary heat source as long as the interior temperature of the RV has not dropped 5° below the thermostat set point. If this occurs, the thermostat will automatically activate your gas furnace.

The furnace will continue as the heat source until the thermostat set point has been satisfied. At that point, the heat pump will again become the primary heat source.

For RV models with a touch screen system, the heating cooling controls are included on the touch screen selectable screens.

For additional information refer to the manufacturer's owner's manual included in your Customer Information Packet or consult your dealer.

"RVing allowed us to feel truly free."

Sonya & Ray
[Maryland]



SECTION 10: APPLIANCES



MICROWAVE

⚠ WARNING ⚠ **⚠ CAUTION ⚠** (See page 88)

For details on operation, cleaning and safety information, refer to the manufacturer's user guide in your Customer Information Packet.

General Cleaning Microwave and Convection Microwave

Before cleaning, make sure all controls are off and the microwave oven is cool. Always follow label instructions on cleaning products.

To avoid damage to the microwave keep the unit's interior, exterior, and filters clean using mild soap, water, and a soft cloth or sponge. For stainless steel use a stainless steel cleaner. Dishwasher cleaning of any components is not recommended.

Convection Microwave (if equipped)

The convection microwave bridges the gap between microwaving your food and conventional cooking. For details on operation and safety information, refer to the manufacturer's user guide.

COOKTOPS, RANGE AND OVEN (IF EQUIPPED)

⚠ WARNING ⚠ **⚠ CAUTION ⚠** (See page 88)

For detailed operating, cleaning, and safety information for any of the devices listed below, refer to the manufacturer's user guide.

Electric Cooktop (if equipped)

⚠ CAUTION ⚠ (See page 88)

Electric cooktops work when connected to a 120-volt power source.

Make sure the burner is off when not in use, and be aware that despite appearing cool, the burner area may remain hot after use.

Induction Cooktop (if equipped)

Induction cooktops work when connected to a 120-volt power source.

Only induction-compatible cookwear with an iron bottom will heat when used on the cooktop. For this reason use caution and do not lay other metal items on the cooktop.

NOTE

Induction cooktops are more efficient and potentially cook faster than other gas/electric cooktops.

Gas Drop-In Cooktops (if equipped)

Depending on your model, it may be equipped with either a 2 burner or 3 burner cooktop. See the manufacturer's instructions for operation information.

Kitchen Range and Oven (if equipped)

NOTE

To help reduce potential condensation or unwanted cooking odors, turn on the overhead kitchen roof vent or the range hood vent (if equipped).

To prevent damage, always use the manufacturer's recommended size flat bottom pan(s). Generally, the pan should be large enough to cover the burner, but not be more than one inch larger than the burner grate.

Do not use a broiler pan, griddle or any other large utensil that covers more than one burner at a time. This will create excessive heat that may cause melting, sooting or discoloration.

The use of undersized pans could expose a portion of the heating element to direct contact and may result in ignition of clothing. Proper relationship of pans to burner will improve efficiency.

Oven (if equipped)

The propane gas oven must have 12-volt power to operate. **Do not use the oven as a storage area.** If you have any questions, contact your dealer or our customer service department.



RANGE HOOD (IF EQUIPPED)

⚠ WARNING ⚠ (See page 88)

If your RV is equipped with a range hood, it will be connected to an exterior vent. The vent has an inner flap with two snaps. This flap should be snapped shut when the RV is in motion, or during storage to keep insects, debris, snow, rain, etc. from entering the RV.

Anytime the stove inside the RV is being used, this flap **MUST** be **unsnapped** and the range hood turned ON to vent fumes outside the RV.

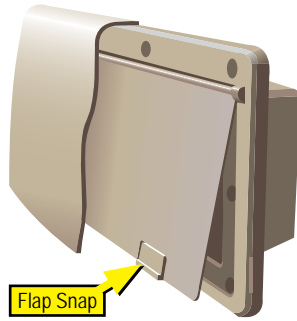

Flap Snap

Push near top of snap to close.
Lift from bottom of snap to open.

Range Hood Exterior Vent Cover

COOKING SAFETY

⚠ WARNING ⚠ (See page 88)

Grease is flammable. Never allow grease to collect around top burners or on the cook top surface. Wipe up spills immediately. Always stay near and pay attention when food is cooking.

In Case Of a Grease Fire

1. Turn off the heat source.
2. Extinguish the fire.
 - Option A. If the fire is in a pan, use a metal lid or cookie sheet to cover the flames. Leave the cover on until the flames are extinguished and the pan is cool.
 - Option B. Pour baking soda or salt on the fire to smother it.
 - Option C. Spray the fire with a Class B dry chemical fire extinguisher.

Additional tips:

- Do not try to extinguish the fire with water.
- Do not attempt to move the pot or pan outside.
- Do not use flour, baking powder or other cooking powders that resemble baking soda or salt – they will make the fire worse.
- If the grease fire cannot be extinguished, evacuate everyone from the RV and call emergency services (911).



REFRIGERATOR

The refrigerator is not intended for quick freezing or cooling. We recommend stocking it with pre-frozen or pre-cooled food when possible. The shelves should not be covered with paper or plastic and the food items should be arranged so air can circulate freely. Keep the area at the back of the refrigerator clean and free of debris. Check for and remove obstructions in the exterior refrigerator vent area (i.e., spider webs, bird nests, etc.).

For detailed operating, cleaning, and safety information for any type or refrigerator listed below, refer to the manufacturer's user guide located in the Customer Information Packet.



NOTE

A good rule of thumb is to have the RV refrigerator running, fully stocked with food (not ice trays), the night before any trip that takes less than a day to arrive. Turn off the refrigerator before you leave for your trip, and everything should stay cold until you arrive on site. Once on site, turn your refrigerator back on.

Gas/Electric Refrigerators (if equipped)

⚠ WARNING ⚠ (See page 88)

The refrigerator control panel is typically located near the top of the unit, or between the freezer and fresh food requirement. Control layout will vary between models, but standard controls include Power, Mode, and Temperature Set buttons.

- **Power:** The unit will default to power OFF, and should only be set to 'ON' once the RV is parked and setup for camping.
- **Mode:** The unit typically has 3 running modes.
 - » **Auto (recommended):** The refrigerator's electronic controls automatically select the most energy efficient source that is available, AC or DC (depending on model). If AC/DC power is not available, the unit will automatically switch to Gas Mode.
 - » **Manual AC/DC:** The refrigerator cools using electric power (AC or DC depending on model) only.
 - » **Manual Gas:** The refrigerator cools using only propane.
- **Temperature Set:** Sets the unit's internal temperature to the preferred setting. Typically the highest setting is the coldest.
- **Night Mode** (if available): Reduces compressor speed for 8 hours, lowering the cooling capacity of the refrigerator. It assumes the unit will be rarely opened and the external temperatures will be lower to conserve energy and lower noise.

Residential Refrigerators (if equipped)

⚠ CAUTION ⚠ (See page 88)

Residential refrigerators use 120V power either from shore power or the battery/inverter system when shore power is not available. Inverter controls are found in the command control panel/system.

12V Refrigerators (if equipped)

⚠ DANGER ⚠ (See page 87)

12v refrigerators run on the 12v electrical system only. Pay close attention to battery levels when not connected to shore power. These units do not have vents on the exterior of the RV.

APPLIANCES

JAYPORT™ AND GAS BBQ GRILL

⚠ DANGER ⚠ ⚠ WARNING ⚠ (See page 87)

Setting up the grill stand.

1. Locate your JayPort™ grill mount receiving hitch location. Depending on your model, your grill will be mounted with either a bumper mount system, or a rail mount with a JayPort™ branded logo on the side of your RV (**Fig 1**).
2. Slide the grill stand into the JayPort™. Make sure to push it in until it stops (**Fig 2**).
3. Place the grill (if equipped or customer supplied) on the grill stand platform. Make sure the grill fits within the platform tray (**Fig 3**).
4. Attach the grill gas line to the quick coupler LP gas connection following the directions below.



Fig 1



Fig 2

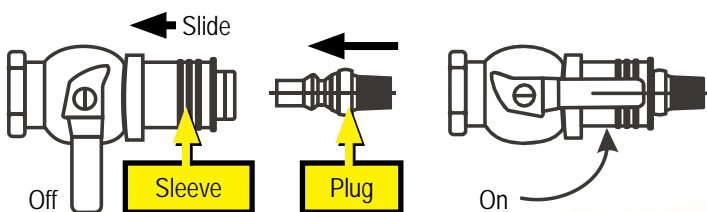

Fig 3

PROPANE GRILL QUICK COUPLER

The "quick coupler" is directly connected to the RV propane system. The "quick coupler" connection is equipped with a positive shut-off valve.

Place the "quick coupler handle in the OFF position and push back the sleeve. The valve handle must be OFF to make the connection.



1. Insert the plug and release the sleeve.
2. Push the plug until the sleeve snaps forward, locking the plug into the socket.
3. Turn the handle ON to allow propane to flow to the unit.

OUTSIDE KITCHEN (IF EQUIPPED)

⚠ WARNING ⚠ (See page 87)

Outside kitchens will consist of a small refrigerator, and possibly an outdoor sink and/or a cooktop. For detailed operation and safety information on the outside kitchen appliances, refer to the manufacturer's user guide.



Outside Kitchen Example

The cooktop will function more efficiently when level.

Outside kitchen access and locking functions may vary depending on your model.

The following applies when using any outside kitchen configuration.

- Make sure all supports are securely in place before using the outside kitchen.
- Before using, make sure the propane connection is properly hooked up and secure.
- Do not leave the cooktop unattended while using.
- Keep all clothing and flammable material away from the cooktop while in use.
- Do not exceed the weight capacity of the outside kitchen unit.
- Disconnect the propane coupler before stowing the outside kitchen unit.
- Make sure the kitchen unit is properly stowed and secured, and that the outside kitchen door is securely in place and locked before traveling.

LP Gas Grill (if equipped)

⚠ WARNING ⚠ (See page 87)

Some models may include an LP fueled BBQ grill in the outside kitchen. This grill may be mounted in a pull out drawer. It attaches to the LP tank using a quick coupler connection as described in the "PROPANE GRILL QUICK COUPLER" section to the left.

For detailed operating, cleaning, and safety information refer to the manufacturer's user guide.



APPLIANCES

TAILGATER CAMP KITCHEN (IF EQUIPPED - SEISMIC)

⚠ WARNING ⚠ (See page 87 and page 87)

Your RV may be equipped with an optional Tailgater Camp Kitchen. It contains a pullout 2-burner cooktop and a small refrigerator. These components are enclosed in a lockable weather-resistant enclosure mounted on the rear of the RV.



Brackets allow the entire enclosure to pivot and swing away from the cargo ramp. The optional barbecue grill can also be attached.

Releasing the outside kitchen

1. Remove the pin from the upper rear hinge (A).
2. Remove the keeper cable from the pin at the right rear of the outside kitchen and pull the pin out of the bracket (B).
3. Open the outside kitchen and pull the inside handle (C) to release the two latches on the rear right and left corners of the enclosure. The enclosure will now swing away from the rear of the RV.

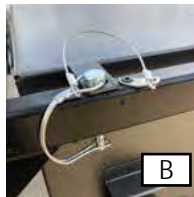

Latching the outside kitchen

1. Push outside kitchen back in place against the rear brackets. The enclosure will latch on each side at the lower rear corners. You should hear it click into place.
2. Replace the pin and the keeper cable at the top right rear corner of the enclosure (B).
3. Replace the pin on the top rear hinge (A).
4. Lock the lid of the enclosure with the keyed locks.

When not in use, the outside kitchen enclosure should be closed and locked.

Hooking up Power

Lighting and the refrigerator in the kitchen require power to operate. To plug the outdoor kitchen into power:

1. Open the power cord access panel at the back of the unit (D) and pull the power cord through it.
2. Plug power cord into available outlet on the RV sidewall (E).



LED Kitchen Interior Lighting

To illuminate the LED lighting built in the outside kitchen, once power has been enabled, flip the lighting switch (F), found at the top center of the interior of the kitchen, to 'On'.



Connecting the grill to the propane "quick coupler"

Install the provided grill propane line between the grill connector (G) through the access hole (H) at the bottom center of the outside kitchen, and the quick coupler (I) found under the outside edge of the RV.



See "PROPANE GRILL QUICK COUPLER" on page 84 for instructions on using the Quick Coupler.

Installing the TV Mount (if equipped)

The Tailgater Camp Kitchen may be equipped with a TV mount (J).

To install the TV extension arm to the mount:

1. Locate the TV extension arm (if equipped), and install a TV to the available VESA mount (K) following instructions provided by your television's manufacturer.
2. With a TV mounted via the VESA connector, place the top of the mounting bracket on the extension arm into the top of the TV mount as show (L).
3. Rotate the bracket down until the bottom of the bracket locks into the TV mount. You should hear a click.



To remove the TV extension arm, while supporting the television, pull the lever (M) to unlock the mounting bracket, and lift to remove the arm assembly from the mount.

Bottle Opener

The Tailgator comes with a convenient Jayco branded bottle opener mounted on one side. To use, hook the edge of the cap inside the top of the opening and carefully rotate the bottle down.



The following applies when using the outside kitchen.

- Before using, make sure the propane connection is properly hooked up and secure.
- When in use, do not leave the cooktop unattended.
- Keep all clothing and flammable material away from the cooktop while in use.
- Disconnect the propane coupler, store the power plug, and remove the TV mount before stowing the outside kitchen unit.
- Make sure the kitchen unit is properly stowed, latched and secured, and that the outside kitchen enclosure is locked before traveling.

APPLIANCES



WASHER/DRYER PREP (IF EQUIPPED)

⚠ WARNING ⚠ **⚠ CAUTION ⚠** (See page 88 & page 88)

If your RV was built with washer/dryer prep, be aware the cabinet space provided is intended for the installation of an aftermarket washer/dryer combo unit (customer supplied) only. Please consult your dealer or the manufacturer for installation assistance.



Washer Water & Drain Connections

A dryer vent opening must be cut into the sidewall of the RV if installing a dryer. A label has been installed to assist you in placing the vent in the correct location. The label will be located in the area where the dryer will be installed.

In some cases the washer/dryer prep is not located near a sidewall. When this happens the vent location sticker will be on the floor showing you where to cut a vent access into the lower storage area of the RV. Within that storage area you will find a second sticker on the side wall showing you where to cut the hole for the exterior vent. This will allow you to run a duct line from the dryer, through the floor, and out the sidewall to your vent.



Dryer Vent Hole Cut Location Sticker

CENTRAL VACUUM SYSTEM (IF EQUIPPED)

⚠ WARNING ⚠ (See page 88)

The following is an overview of the central vacuum system operation. For detailed operating and safety instructions, refer to the manufacturer's user guide found in the Customer Information Packet.

The central vacuum system cleans virtually any surface with no electric cords and has a variety of attachments for many cleaning needs. Make sure you have 120-volt AC power available before operating your central vacuum system.

To operate the central vacuum system, lift the vacuum cover and attach your vacuum hose and cleaning attachment. The central vacuum will automatically activate.

The system also includes a Broom Debris Vacuum. To use simply sweep debris towards it, then lift the on/off switch with your foot. It will vacuum up any debris in front of it.

The system has a large disposable bag that will need to be checked periodically and replaced after usage. The disposable bag is located inside the exterior cargo compartment. There is a second hose attachment port at this location as well.



Cargo Area Vacuum Access

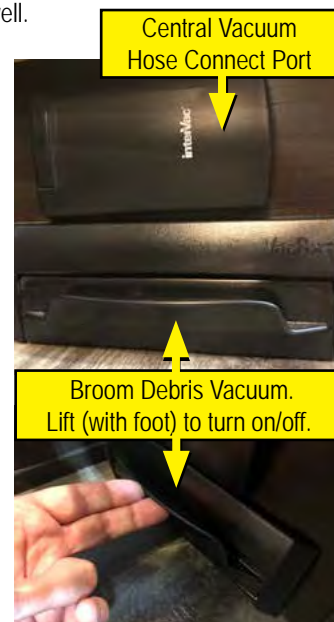

Interior Vacuum Access



"Having an RV has allowed us to explore year-round..."

Alison & Jacob
[Texas]

 **DANGER** 

APPLIANCES DANGER

JAYPORT™ AND GAS BBQ GRILL (page 82)

Always open the grill lid before turning on gas and lighting burner. Failure to open the lid before lighting could cause an explosion causing property damage, injury, or even death.

12V REFRIGERATOR (page 83)

RISK OF FIRE OR EXPLOSION. Flammable refrigerant used. Do not use mechanical devices to defrost refrigerator. Do not puncture refrigerant tubing. To be repaired only by trained service personnel.

 **WARNING** 

APPLIANCES WARNING

LP GAS GRILL (page 84)

TAILGATER CAMP KITCHEN (page 85)

The grill requires proper ventilation. It is designed for RV outdoor use only.

Never put lava rocks or charcoal or anything else on or under the grate. The grill is designed so it does not require those items. Serious injury or property damage can occur by placing foreign objects on the grate.

Never touch the grate when it is hot. Use the spade (grate handle) supplied with your grill.

Be sure to read, understand and follow all information supplied with your recreation vehicle concerning the use of propane before operating the BBQ grill. The propane hose must be correctly connected before lighting the grill. Failure to follow instructions supplied by the grill manufacturer, or use of any components other than those originally supplied with the grill, could result in death or serious injury.

If you smell gas, shut off gas to the appliance, extinguish any open flame, and open the lid. If odor continues, immediately call you gas supplier or your fire department.

The BBQ grill is for use outside of the recreational vehicle. Never use this grill inside a compartment or inside of the recreational vehicle. Make sure the grill is pulled completely out of the drawer before attempting to use it.

Install the drip pan under the grill to catch hot grease and liquids. Failure to use the drip pan can cause personal injury including burns from hot grease.

The BBQ grill must be completely cooled before storing. Storing the BBQ grill before it is completely cool may result in serious injury or property damage.

Do not cover the cooking surface with a dust cover, lid, foil, cooking utensil or anything else. Covering the cooking surface can cause an unsafe situation and can lead to serious injury or property damage.

OUTSIDE KITCHEN (page 84)

The maximum weight capacity of the outside kitchen unit is 50 lbs. Setting items on the kitchen unit that exceed this weight limit could cause damage to the unit or result in personal injury.

JAYPORT™ AND GAS BBQ GRILL (page 84)

Be sure to read, understand and follow all information supplied with your recreation vehicle concerning the use of propane before operating the BBQ grill. The propane hose must be correctly connected before lighting the grill. Failure to follow instructions supplied by the grill manufacturer, or use of any components other than those originally supplied with the grill, could result in death or serious injury.

If you smell gas, shut off gas to the appliance, extinguish any open flame, open lid. If odor continues, immediately call you gas supplier or your fire department.

The maximum weight limit for the bracket supporting your BBQ grill is 50 lbs. This limit includes the weight placed on the BBQ grill. Exceeding this weight limit could result in injury or property damage.

The BBQ grill is for use outside of the recreational vehicle. Never use this grill inside a compartment or inside of the recreational vehicle. Before operating the BBQ grill, make sure that it is securely mounted on the support rail attached to the side of the recreational vehicle (if equipped) or the bumper mounting bracket (if equipped).

The BBQ grill must be completely cooled before storing. Storing the BBQ grill before it is completely cool may result in serious injury or property damage.

TAILGATER CAMP KITCHEN (page 85)

The maximum weight capacity of the outside kitchen unit is 75 lbs. Placing any items on (or in) the kitchen unit that exceed this weight limit could cause damage to the unit or result in personal injury.

The outside kitchen enclosure is not designed for; nor should it be used as; an accessory carrier or to attach any external gear, items or equipment.

Do not use the outside kitchen enclosure as a storage compartment.

OUTSIDE KITCHEN (page 84), TAILGATER CAMP KITCHEN (page 85), JAYPORT™ AND GAS BBQ GRILL (page 84)

When using this outdoor cooking area, the vehicle must be level and stabilized.

Do not violate manufacturers' instructions on required clearances for cooking appliances during use.

Do not store cooking appliances until cool to touch.

Can lead to a fire and explosion and result in death or serious injury.

5.8.1.2.8

WARNING

APPLIANCES WARNING Continued

MICROWAVE (page 82)

The microwave cavity should always be empty when not in use. Never use for storage.

COOKTOPS, RANGE AND OVEN (page 82)

During and after use, do not touch or let clothing or other flammable material come in contact with the top burners or heating elements, burner grates or areas near the top burners or oven until they have had sufficient time to cool. These areas can get hot enough to cause burns.

Never leave cooking food unattended. Turn pan handles inward, but not over the tops of the other range burners. Ensure that pans used are large enough to contain the food and avoid boil-overs. Heavy splattering or spills left on the cooktop can ignite and cause burns.

If using glass, glass/ceramic, ceramic, earthenware or other glazed utensils or cookware verify it is safe for use on the top burners.

Do not cover the oven vent openings while the oven is in operation. Restricting the flow of combustion air will create an asphyxiation hazard.

RANGE HOOD (page 83)

Whenever the stove in the RV is being used, the range hood **MUST** be turned on, and the inner flap **MUST** be unsnapped and free to move. Failure to do so can create an asphyxiation hazard by restricting airflow through this vent.

MICROWAVE (page 82)

To prevent damage, remove the turntable from the microwave when traveling.

Make sure you are connected to a 120-volt power source.

COOKTOPS, RANGE AND OVEN (page 82)

Never use oven cleaners, chlorine bleach, ammonia, or glass cleaners with ammonia. Always allow the cooktop to cool before cleaning.

ELECTRIC COOKTOP (page 82)

Do not use aluminum foil under any circumstances on the electric range cooktop, as this material will damage the cooktop surface if it melts.

COOKING SAFETY (page 83)

Do not attempt to use water to put out the fire. Water can spread some types of fire, and electrocution is possible with an electrical fire.

GAS/ELECTRIC REFRIGERATORS (page 83)

If you smell propane gas STOP! Follow the directions located in your manufacturer's user guide and in this manual under "PROPANE USE AND SAFETY" on page 57.

WASHER/DRYER PREP (page 86)

Gas dryers should NEVER be installed in your recreation vehicle. Dryer prep has been designed for electric dryer operation ONLY.

CENTRAL VACUUM SYSTEM (page 86)

DO NOT PICK UP ANYTHING THAT IS BURNING OR SMOKING, SUCH AS CIGARETTES, MATCHES, OR HOT ASHES. RV damage, personal injury, or death may result from vacuuming up burning or smoking material.

DO NOT PICK UP FLAMMABLE OR COMBUSTIBLE LIQUIDS SUCH AS GASOLINE, OR USE IN AREAS WHERE THEY MAY BE PRESENT. RV damage, personal injury, or death may result from vacuuming up flammable or combustible material.

CAUTION

APPLIANCES CAUTION

RESIDENTIAL REFRIGERATORS (page 83)

The ice maker should be turned off and the ice tray emptied when power to your motor home has been shut off. With no power, the ice will melt and water will "pool" in the refrigerator door. When power is restored, the vibration will cause this water to run out of the door and on to the motor home floor.

WASHER/DRYER PREP (page 86)

Do not operate a dryer in the recreation vehicle unless the dryer is properly vented.



SECTION 11: ELECTRONICS



WINEGARD® AIR™ 360 ANTENNA

HDTV/FM Radio Antenna

Your RV is equipped with an exterior, fixed-height, high definition TV and FM radio antenna. The antenna is omnidirectional so it will receive TV signals from all directions. The antenna height is 8" above the roof. Refer to the manufacturer's manual for detailed operating and safety information.



Omnidirectional HDTV Antenna (Style May Vary)

NOTE

A channel scan must be run to search for and tune in local TV channels. Trees and foliage will interfere with OTA (Over-The Air) high definition channel reception.

WineGard® Air™ 360 Plus (if equipped)

The Plus model adds an HDTV antenna amplifier, Wi-Fi extender antenna to pick up open Wi-Fi signals in the immediate area, and is 4G or 5G capable (data plan required). You will need the optional Winegard Gateway Router to take advantage of the Wi-Fi and 4G/5G features.

Antenna Power Supply (if equipped)

For better TV station reception, the antenna power supply should be turned ON. Turning the antenna power supply ON sends 12-volt DC to the TV roof antenna turning the antenna amplifier ON. Turn the antenna power supply OFF to view cable television. The ON/OFF switch is located on the wall plate for the antenna connection, found near the TV in the main living area. An LED will light to indicate when antenna power is ON.



Power Supply Switch

Wi-Fi Router and 4G/5G Prep (if equipped - Plus Only)

Wi-Fi/4G/5G prep may be available on your RV ceiling, located directly beneath the roof mounted HDTV antenna. Wiring found under the cap connects a compatible gateway router to Wi-Fi and 4G/5G antennas within the HDTV antenna dome. Refer to the HDTV antenna/router manufacturer's documentation for more information.

WINEGARD® GATEWAY ROUTER (IF EQUIPPED)

Your RV may be equipped with a router compatible with your HDTV antenna, or a compatible router may be installed by your dealer to the Wi-Fi prep location if available. An installed router amplifies weak external Wi-Fi signals, acts as Wi-Fi hotspot, and can connect to 4G or 5G (data plan required) for internet access. Refer to the router manufacturer's documentation for more information.



Wi-Fi Prep Location (Found on Ceiling of RV)



Gateway Router

This router receives a cellular data connection through the use of a SIM card supplied by your cellular provider or through Winegard. The Winegard SIM card comes pre-installed in the router box (data plan required). Presently the system works with the following wireless providers: Winegard, Verizon, T-Mobile, and AT&T. A SIM card is available from your cellular provider.

A power switch next to the prep location/router turns the power to the router off and on. If the switch is left continually ON, over time it could drain your battery. When leaving the RV or when the network is not in use, this switch should be turned OFF.

NOTE

You MUST turn the power switch ON or there will be no cellular or Wi-Fi signals from the router box.

Winegard® Mobile Apps

Winegard has two free apps that can be downloaded for Android or iPhone to help locate TV and Satellite signals: TV Signal Finder and HD Tower Finder. These apps will help you determine HDTV tower locations and satellite dish pointing coordinates.

Wi-Fi Control

The Wi-Fi function on your smartphone, tablet, or other smart device must be enabled in order to detect the SSID from the router and connect to the system.

Router Password, Serial number, IMEI number

This information may be located in one of the following places.

- On a small vinyl tag (or label) near the entrance area to the RV. The label may be located in a nearby cabinet.
- On a tag (or label) on the Winegard Gateway instruction manual (in your Customer Information Packet).
- On the backside of the ceiling mounted router box.

Router Setup:

The router can be set up using a cell phone connected to the internet using the Winegard-Connected app, or through the JAYCOMMAND/TravelLink system (if equipped). Reference the JAYCOMMAND/TravelLink's and the router's user guides for additional information.

CAMERA PREP/CAMERA (IF EQUIPPED)

Camera Prep

Your RV may be pre-wired to allow for installation of a (customer



Rear or Door Camera Prep



Side Marker Camera Prep

supplied and customer installed) rear vision, door, and/or side marker camera. To install a camera, refer to the manufacturer's installation guide.

Camera/Monitor

The rear and side vision monitor gives a limited televised view of what is behind and along side of



Rear or Door Camera



Side Marker Camera

you. Camera's are powered along with the JaySMART™ safety marker and reverse travel lighting system when your tow vehicle's headlights are turned on. The monitor's display will switch to the appropriate side marker camera when a turn signal is used.

For detailed operating and safety information, refer to the manufacturers user guide.

Some models are equipped with a camera accessory power wire that is pre-routed behind the bedroom light switch; or if there is no light switch, behind the command center panel near the entrance door. A switch can be installed, using that wire, to turn the camera's on/off when the RV is not attached to a tow vehicle.



12V Power Port

If available, the wireless camera monitor may then be plugged into the 12v power port in the bedroom to be used for observation or security purposes.



Camera/monitor system aids in the use of, but does not replace vehicle side/rear-view mirrors.

Objects in camera/monitor view are closer than they appear. When backing up, proceed cautiously and be prepared to stop.

EXTERIOR SLIDING / PIVOTING TV (IF EQUIPPED)

Your RV may be equipped with a TV located in an exterior compartment that allows you to slide it in and out of the compartment, along with the ability to pivot and reposition for viewing.

Extending the TV for viewing

1. Push down the yellow tipped lever to release the sliding bracket.
2. Hold the yellow lever down (A) and pull the TV towards you out of the compartment. Once you start sliding the TV out, release the lever and continue pulling the TV out. Make sure the cords do not get caught in the mechanism as the TV is pulled out.
3. With the silver brackets (on the back of the TV) extended, the TV is not completely out of the compartment. Continue pulling on the TV until the top black slide bracket (B) is all the way out to the end of the channel (C). The TV should clear the lined panel inside the compartment when it is completely extended (D).
4. To pivot the TV, pull up on the T-handle (E) which releases the TV to pivot freely.

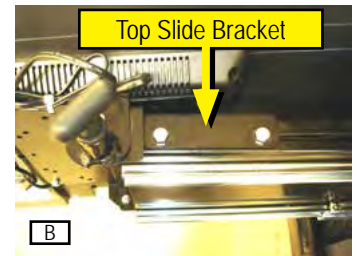
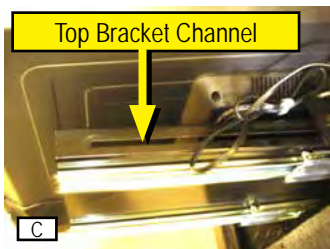
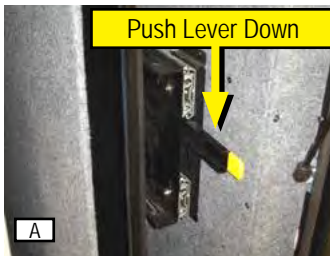

NOTE

The TV does not lock into place when it is in the pivoting position.

Retracting the TV for storage

1. Rotate the TV back into the storage position so the T-handle (E) locks back in place to keep the TV from pivoting.
2. Push the TV into the storage compartment taking care not to get the power cord or the antenna cable caught in the mechanism.
3. Push it all the way back into the compartment until it stops. Firmly push it into place until the yellow tipped lever locks it in place. You will hear it click when you have it latched properly.

SECTION 12: INTERIOR



CLEANING THE INTERIOR

To keep the value of your RV, perform regular maintenance using the proper materials and procedures. Using the wrong cleaner may result in damage to the surfaces in your RV. Check with the manufacturer's information for the recommended cleaning agent. If in doubt, check to see if the cleaner will cause damage by testing a small area out of sight or contact your dealer for assistance. Do not use flammable liquids or sprays to clean the RV. For most surfaces, do not use abrasive cleaners or cleaners that contain bleach.

Fabric, Leather, and Ultraleather™ (if equipped)

It is recommended that fabric, leather and Ultraleather™ be professionally cleaned if it becomes stained or soiled. The cleaner should be made aware that the fabrics may have been treated to be fire resistant.

Window Treatments

Dust occasionally with a vacuum and soft brush attachment. It is recommended the fabric be professionally cleaned if it becomes stained or soiled. The professional cleaner should be made aware the fabrics that may have been treated to be fire resistant. Refer to the shade manufacturer's owner's manual for additional and detailed information.

NOTE

If your RV must be stored for an extended period, store shades in the up position and cover your windows with additional protection.



SOFAS AND DINETTES

Your RV may be equipped with one or more of the following sofa styles.

TriFold Sofa Sleeper (if equipped)

To make the sofa sleeper into a bed:

1. Remove the back cushions and lift up from the front of the bottom seat cushion and pull it towards you.
2. Extend the legs under the seat cushion area and lower to the floor (B).
3. Pull the head board towards you (C).
4. Put the back cushions back in place at the back (D).

To convert the hide-a-bed back into the upright sofa position, reverse the process.

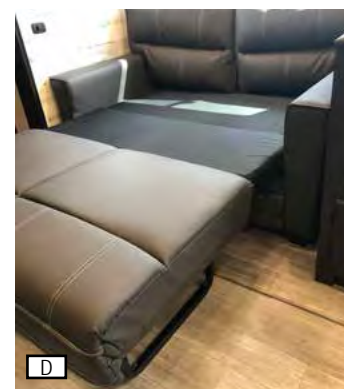

INTERIOR

Jack Knife Sofa

The jack knife sofa functions much the same as a residential futon. To make the sofa into a bed, lift up on the bottom seat cushion (E) and pull it towards you. The sofa back will drop down to provide a sleeping surface (F). For additional comfort and to reduce fabric damage, you may want to place a cover or air mattress (customer supplied) over the sofa when it is in the sleeping position.



E



F

Jay Cube™ Sofa (if equipped)

The Jay Cube™ Sofa functions similar to a residential futon. The slanted back pillows offer numerous options as a sofa, along with the ability to extend the cushions for additional sleeping space.



“Living small has actually allowed us to live large.”

Tina & Craig
[Full Time RV]

Booth Dinette (if equipped)

The dinette is designed to seat up to four adults. Depending on your model, there may be a storage area in the dinette bench. To access this storage, remove all the cushions and lift up on the bottom seat support. **If the bottom seat support is secured closed with screws, do not remove the seat support or use this area for storage.** The dinette seats that are secured with screws contain factory installed equipment and should only be accessed by a qualified service technician.



G

To convert the dinette into a bed:

1. Remove all the cushions from the booth dinette.
2. Lift up the tabletop and remove the detachable table legs.
3. Place the tabletop on the ledges provided between the booth dinette benches (H).
4. Lay the seat back cushions on each dinette bench.
5. Lay the dinette seat bottom cushions in between the seat back cushions (I). The area where the cushions meet should be slightly raised. Push the raised cushion ends down gently as the cushions are designed to fit snugly.



H



I

Reverse this process when converting back to the booth dinette.

Free-Standing Table and Chairs (if equipped)

The free-standing dinette table can be positioned to seat up to four people. To prevent damage, the free-standing dinette chairs should be fastened securely at the dinette table when traveling (J).



J

Table extension (if equipped)

Pull to lengthen (K). Lift the main top and push in to shorten.



K



TOKYO BED (IF EQUIPPED)



The cargo bay of a toy hauler may be equipped with a Tokyo Bed which uses a scissor rail system to raise and lower the bed. To lower the bed, grasp the hanging strap and pull down until the bed stops. Make sure there are no items below the bed that are in the way. Do not sleep in the bed when internal combustion engines are stored beneath it.

To store the bed, with nothing on the bed, simply push the bed back up. Never attempt to raise the bed with a person still in the bed.

A ladder is provided that hooks over the outside rail in order to access the bed when lowered. Store the ladder when not in use.

The bed should be empty and kept in the up position for travel and when not in use. The bed should not be used for storage.

The maximum weight capacity of the Tokyo Bed is 550 lbs. Do not exceed the weight rating.

POWER BUNK BED (SEISMIC CARGO BAY)

⚠ DANGER ⚠ **⚠ WARNING ⚠** **⚠ CAUTION ⚠**
(See page 97)



Your RV may be equipped with a queen-size power bunk bed in the cargo bay. Included in the cargo bay are powered sofa seats that fold out into a second queen size bed. These sofa seat/beds can be raised up to the ceiling just underneath the powered queen bed to allow loading of the cargo area. They operate using the same controls as the queen bed.

CHECK:

- To make sure the attaching pins are securely fastened at all (4) corners of the bed platform before towing the trailer, or using the bed(s).
- To make sure the area around, above, below and adjacent to the bed(s) is clear of persons, pets and obstructions before operating the bed(s).
- Before operating the bed(s), ensure that bedding is not overhanging the ends of the bed(s) where it could become entangled.
- To make sure the brake is set on the bed lift mechanism or the bed can drift down and damage objects or vehicles placed below the bed(s).

NEVER:

- Operate the bed(s) with any items other than the mattress, pillows, blankets, etc. on the bed platform.
- Raise the sofa seats when set in the seated position. They must lay flat and be locked.
- Travel with loose items other than bedding on the bed(s). Loose items become projectiles.
- Operate the bed(s) when persons are on the bed platform.
- Hang from, or hang more than 20 pounds from the cross-connecting shaft.
- Allow anyone to ride or occupy the bed(s) while the RV is in motion.

ALWAYS:

- Exercise care when loading cargo/vehicles in the cargo area to avoid damage to the bed mechanism.
- Secure loads properly in the cargo area to avoid damage to the bed mechanism from shifting or falling loads.

Bed Operation

The electric bed lift operates on 12-volt DC power supplied by the tow vehicle charge line, auxiliary batteries, or power converter. The RV should be hooked up to 120-volt AC power and have the power converter operating, if possible.

There are two separate switches used to operate the bed lift; a red-lighted master shutoff switch and the bed lift up/down switch. Both are typically located in the command center panel. In some models, the master switch is still on the command center panel but the bed-lift control switch may be located in the cargo bay area.

The red master switch must be turned on first allowing the bed to be lowered or raised using the bed lift control. Remember to turn the master switch OFF after moving the beds.



Bed Lift Control Up/Down Switch

INTERIOR

Convertible Sofa

To convert the sofa into the bed position, pull forward on the top of the sofa back (A). As the sofa back comes forward, grasp it at the bottom and rotate the seat back until it reverses (B) and lays flat next to the sofa seat (C). Repeat this process on the sofa on the other side of the RV. Set the sofa lock mechanism to the "LOCK" position (D) This locks the sofa into the bed position.

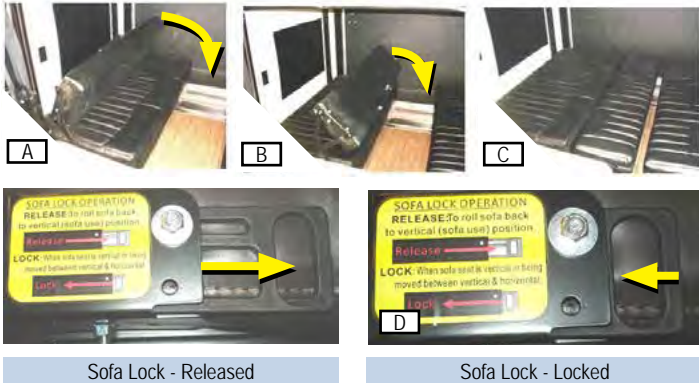

To convert back into the sofa position, reverse the process.

NOTE

The bed must be fully lowered to convert it into the sofa.

Lowering both Beds

Press "Down" on the Bed Lift Switch Control. Both beds will lower together until the upper bed reaches the pre-set stopping point. The bottom convertible sofa continues lowering until it also reaches a pre-set stopping point. Make sure to lower the sofa legs before bringing the convertible sofa to the bottom position.



Adjustable Sofa Leg

Raising the Beds

Before raising the beds, set the lock levers on each rail to the "Lock Bunk" down position. You **MUST** set all 4 levers.

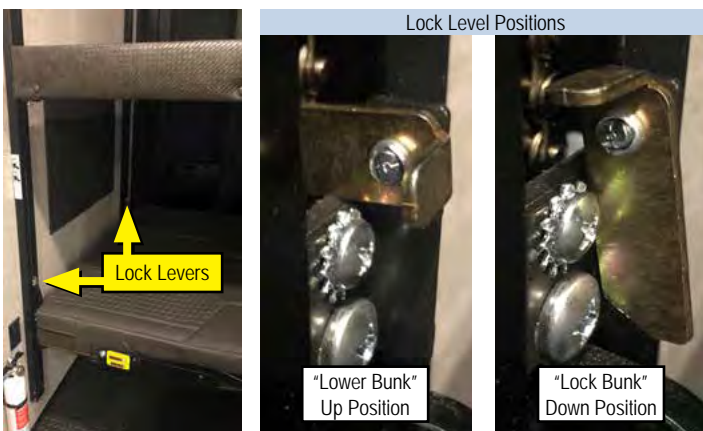

Press "Up" on the Bed Lift Switch Control until the top bunk reaches the maximum height and locks into place. When raising the beds, the bottom bed will rise until it meets the upper bed, then both will rise to the highest point.

Once the upper bunk is locked into place, you can leave both bunks in this position (be sure to lock the sofa legs in the up position), or you can lower the lower Convertible Sofa independently for use leaving the upper bunk at the top (make sure the sofa legs are down). See the **Convertible Sofa** section above to prep the sofa.

Lowering the Upper Bunk for Use

Make sure the Convertible Sofa is in the bed configuration. Set the 4 lock levers on each rail to the "Lower Bunk" up position. Press "Up" on the Bed Lift Switch Control until the Convertible Sofa reaches and unlocks the upper bunk. Continue by following the "Lowering Both Beds" section above.

There is an emergency manual override which allows the beds to be lowered or raised manually in the event the motorized lift becomes in-operative.

Refer to the manufacturers' bed-lift user manual for additional information regarding upper bunk operation, stowing, manual override feature, and troubleshooting.

Storing the Sofa on the Wall

⚠ WARNING ⚠ (See page 97)

In case you need additional width in the cargo area, the Convertible Sofa can be stored against the sidewalls.

This procedure is easiest to perform with 2 people and the back door open.

1. Make sure the sofa is in bed configuration, and the upper bunk is at it's maximum height.
2. Press 'UP' on the Bed Lift Switch Control to raise the Convertible Sofa at least 5' from the floor.
3. Insure the Sofa Lock is in the Locked position.
4. With 1 person on each end of a sofa seat, remove the locking pins (E) on each side. The seat should not immediately drop, but for safety support the seat with one hand as you remove the pin with the other.
5. Lift the seat from both sides, and pull slightly away from the wall.
6. Lower seat to the sidewall
7. Replace locking pins (so they don't get lost)
8. Repeat for the other side.



Locking Pin

Reverse the above procedure to put the sofa back in seating position.



MURPHY BED (IF EQUIPPED)

⚠ CAUTION ⚠ (See page 97)

Your RV may be equipped with a folding Murphy bed. When in the closed position, the bed is stored in the wall allowing for more living space within the RV. When you want to use the bed, the sofa folds flat and the bed can be pulled down over the sofa into the sleeping position.



Stored Position



Sleeping Position

Unfolding the Sofa

With the slideout fully extended, unfold the sofa into the flat position.

- Standing at the side of the sofa, grasp the front of the seat cushion and the top of the back cushion (A) (arrows).
- Lift up on the seat cushion while pulling the top of the back cushion in toward the seat. The seat and back will form a "V" shape. (B).
- Pull the seat cushion out away from the front of the sofa into the flat position (C).



Lowering the Murphy Bed

- Unlatch the bolt latches on one or both sides of the bed platform (in the stored position). This will release the Murphy bed allowing it to unfold.
- The bed will begin to unfold. Lower it all the way down so the bed platform rests on the flattened sofa.



Bolt Latch

Storing the Murphy Bed

⚠ WARNING ⚠ (See page 97)

- Push the bed back up into the storage position. The bolt latch or latches should click into place.
- Test the bolt latch or latches to make sure they are secure.
- Flip the sofa back up into the seated position:
 - » Firmly grasp the edge of the top cushion and the front edge of the seat cushion.
 - » Push the cushions down and towards each other so they form a "V" shape.
 - » While holding the cushions in this "V" shape, rotate the sofa back towards the wall and the cushions will revert to the seated position.

STANDARD BED STORAGE

⚠ WARNING ⚠ (See page 97)

Additional storage has been provided under the bed. To access the storage area, grasp the ledge at the foot of the bed and lift carefully. **The bed platform must be held when raised.**

It is recommended that two people retrieve stored items from under the bed so that one person may hold the platform, and the other can retrieve the stored items from under the bed. Lower the platform slowly to close it. **DO NOT DROP THE PLATFORM.**

Gas Struts (if equipped)

On certain models, the bed platform may be equipped with gas struts to assist with easy access to storage area.

- Grasp the ledge at the foot of the bed and lift carefully.
- Two gas struts will hold the bed platform open allowing access to the storage area.
- To close, carefully push down on the bed, slowly easing it to the closed position.



BUNK BED AND LOFT LADDERS (IF EQUIPPED)

⚠ WARNING ⚠ (See page 97)

Your RV may be equipped with a loft or bunk bed sleeping area. Access to the upper sleeping area is through the use of a separate steel ladder or a wall mounted wooden ladder.

NOTE

Some types of bunk beds do not include a ladder.

Steel Ladder

The steel ladder (A) is equipped with hooks (B) that either fit into mounting points in side board of the loft bed or over the edge of the side board itself. Make sure the ladder is securely in place prior to climbing to or from the loft. Store the ladder when not needed, as access to any nearby doors may not be possible while it is in place.



Wood Ladder

Typically the wood ladder is attached to a wall (C). Simply lift and pull to place the ladder in the out and climbable position (D). Reverse the procedure to store the ladder when not in use.



BED RAILS

(FOR ELEVATED BEDS AND ELECTRIC BED LIFT SYSTEMS)

⚠ CAUTION ⚠ (See page 97)

Standard Elevated Beds

Various products are equipped with standard built-in elevated beds or bed loft areas. These beds can be upwards of 4 to 5 feet above the floor level and are often enclosed on one, two, or three sides and sometimes even partially on a fourth side. Because there are so many potential users and different types of elevated bed designs, elevated beds are not equipped with bed rails.

Electric Bed Lift Systems

Many of the Sports Utility Trailers/Toy Haulers come equipped with rear cargo area electric bed lift systems. (See the label in the Toy Hauler for proper operation of the rear cargo area electric bed lift systems). The bottom beds in some floor plans also can be converted to dual sofas. Again, like the standard built-in elevated beds, because of the design and the various uses, the rear electric beds are not equipped with a bed rail system.

Use of Bed Rails

We feel that you, as the customer, are best equipped to determine if a bed rail system is necessary or best for you based on your intended uses, the actual users of the elevated beds, and the comfort level of the users.

For those customers who would prefer using an elevated bed with a bed rail, there are numerous bed rail styles, sizes, heights, and designs available, even in the style of bumpers, which can be purchased at various retail locations and/or on the internet.

When installing a bed rail please make sure that you follow the manufacturer's installation instructions carefully and that you take in to account the size and height of the mattress (either originally installed or later replaced by you) so that the rails are the appropriate height above the top of the mattress. This is important because residential mattresses differ in size from the RV mattresses originally installed.

Please also make sure that the bed rail you select allows for adequate room to get in and out of the elevated bed after installation, especially in the event of an emergency.

Tips for Safe Usage:

- Please use sound judgment when allowing children to sleep in any style of elevated bed. Generally, it is not suitable for children under the age of 6 to sleep in an elevated bed or bed loft area.
- Discuss proper usage of any elevated bed/electric bed lift system with your children and make sure they are supervised if playing in the bedroom/sleeping area of the trailer with elevated beds. Please do not allow horseplay on or under the elevated beds and no items such as hooks, belts, jump ropes, or towels should hang from any part of the elevated bed.
- Place a night light in the bedroom/sleeping area so users can see at night when getting in and out of the beds.
- No more than one person should be in an elevated bed at once and make sure you follow the weight restrictions posted on the warning label near the beds.
- Do not allow children to operate the rear cargo area electric bed lift systems in Toy Haulers. The lowering and raising of the electric beds should be only conducted by an adult. No person should be on the electric beds when being lowered or raised.

If you have any questions about elevated beds, Toy Hauler electric bed lift systems, or bed rails please contact our Customer Service Department.

 **DANGER** 

INTERIOR DANGER

POWER BUNK BED (page 93)

This product is designed and intended ONLY to be used as a Bed-Lift mechanism. Any other use of this system can result in personal injury or death.

 **WARNING** 

INTERIOR WARNING

POWER BUNK BED (page 93)

DO NOT LOAD MORE THAN 600 lbs. ON THE BED. Damage to the bed lift mechanism and personal injury may result from overloading.

STORING THE SOFA ON THE WALL (page 94)

Make sure the area around, and below the bed is clear of persons, pets, and obstructions before attempting to lower the sofa seats to the sidewalls. Failure to do so risks serious injury to anyone caught beneath.

STORING THE MURPHY BED (page 95)

Keep hands and fingers away from the collapsing footboard and struts when pushing the bed back in to the storage position.

BED STORAGE (page 95)

Before lifting, be sure there is nothing on the bed that will restrict its movement or add extra weight.

Use caution when opening or closing the bed to keep hands and fingers at the end ledge provided (not on the side or farther back than necessary).

Exercise extreme caution when opening the bed storage platform. Platform must be held open (unless equipped with gas struts) and slowly lowered until closed.

Failure to comply with these guidelines can result in serious injury or property damage.

 **CAUTION** 

INTERIOR CAUTION

POWER BUNK BED (page 93)

To avoid damage to the bed(s) as a result of bouncing RAISE BOTH REAR BEDS TO THE HIGHEST POSITION WHEN TOWING YOUR RECREATION VEHICLE.

The powered sofa seat/beds in the cargo bay MUST be folded flat into the sleeping position before raising them up under the upper bed for loading the cargo bay. DO NOT operate the bed lift when seats are opened in the seating position.

Seats should be locked in the flat (bed) position using the sofa lock mechanism.

BUNK BED AND LOFT LADDERS (page 96)

Exercise extreme care when climbing up or down the ladder used for entering or exiting the loft bed.

Nearby doors MUST be securely closed and latched before using the ladder.

Make sure the ladder is securely in place prior to climbing to or from the loft.

Never allow more than one person on the ladder at a time.

Make sure the wood ladder (if equipped) is locked back into position when not in use to prevent a trip hazard.

Do not leave small children unattended in the loft area.

Maximum weight rating for either ladder type is: 300 lbs (136 kg)

Weight ratings for loft sleeping areas may vary by RV type and model:

Refer to the maximum weight rating label located at the loft sleeping location.

Never allow anyone to ride in or occupy the bed while the recreational vehicle is in motion.

Do not use the loft sleeping area for storage while the vehicle is in transit. Loose items may become projectiles.

Failure to follow these instructions can result in serious bodily injury.

MURPHY BED (page 95)

The slide out must be fully extended before putting the Murphy bed in the sleeping position. The Murphy bed must be in the stored position before the slide out can be moved to the in (travel) position. Failure to do so may result in injury or property damage.

BED RAILS (page 96)

300 lbs (136 kg) Max. load capacity

Failure to comply with the load capacity could cause bed failure which may result in injury.

Bed(s) must be stowed in the up position during travel.

Elevated beds may present a fall hazard which may result in injury. Please consult the Owner's Manual for more information regarding elevated beds and the use of bed rails.

SECTION 13: EXTERIOR



CLEANING THE EXTERIOR

To protect your RV's exterior finish, wash it often and thoroughly.

Your RV is exposed to many environmental conditions that have an adverse affect on the finish:

- Road Salt
- Road Tar / Bugs
- Bird Droppings / Tree Sap
- Industrial Fallout / Acid Rain / Pollution
- UV Exposure
- Moisture

The most common problems resulting from these conditions are corrosion, staining, and chemical spotting. Generally, the longer the foreign material remains in contact with the exterior finish, the more extensive the damage. These problems can be minimized by regularly scheduled cleanings. Wash your RV as soon as possible if it becomes contaminated with foreign material.

Avoid parking directly under trees, in direct sunlight, or near ocean sea salt. Ice or snow should be brushed off, not scraped, from the surface. Avoid gravel roads.

Washing

Commercial washing, and high pressure sprayers should be avoided. Wash with cold water using a mild liquid soap. Dry wiping with a dry cloth is not recommended.

Make sure the RV's surface temperature is cool, under 90° F, and out of direct sunlight. A shaded area is ideal for washing your RV as direct sunlight causes water spotting. Use a mild soap, detergent or car wash shampoo. Wash-n-wax products are recommended.

Have two dedicated sponges or wash mitts: one for the sides and one for the wheels and under carriage. Brushes or wash mitts made of plastic bristles are acceptable for use on tires and wheel wells, but are not intended for use on the sides. Wash the wheels and wheel wells first as this removes heavy dirt and debris and prevents it from splattering on panels. Wet the entire area down to remove loose dirt and grime, then hand wash one area at a time using your dedicated

sponge or wash mitt. Wash from the top and work your way down, rinsing frequently to minimize grit abrasion. Follow with a final rinse of water. This process will remove most contamination from the RV's surface.

For stubborn stains such as road tar or bug stains, use an ammonia based glass cleaner or a small amount of rubbing alcohol on a damp cloth followed immediately by warm soapy water, and rinse with clean water. This may not dissolve the road tar, but it will loosen tar and bug stains and remove them from the surface.

Do not use solvent based cleaners on bird droppings or tree sap as these are water based stains. They can be dissolved using ammonia based glass cleaner, warm soapy water and a little "elbow grease". After removing stubborn stains immediately rinse with clean water.

Drying the RV is just as important as washing it. Tap water and well water contain many chemicals that could water stain your RV's finish.

We suggest using a damp natural or synthetic chamois. There are other drying products such as lint-free micro-fiber towels that work just as well.

Painted Surfaces

⚠ CAUTION ⚠ (See page 102)

You may wash and wax your new RV 60 days after purchase. The exterior paint needs time to cure before any wax is applied to the exterior surface. Careful maintenance for the first 60 days will assure a long lasting durable finish.

Anti-freeze, gasoline, or washer solvents, if spilled on the painted surface, should be rinsed off with water immediately. Bugs and bird droppings should be rinsed off daily.

Wax your RV once or twice a year, or when painted surfaces do not shed water well. Use a soft cloth to apply a small amount of wax to the painted surfaces. After the wax has dried, polish the RV with a dry, soft cloth.

Do not wax your RV in direct sunlight. Wax it after the surfaces have cooled. Do not apply wax to any area having a flat black finish as it can cause discoloration. If the finish has been stained with wax, wipe off the area with a soft cloth and warm water. When waxing the area around the various openings, do not apply any wax on the weather

strip. If it is stained with wax, the weather strip cannot maintain a weatherproof seal around the opening.

Damaged Paint

If painted surfaces have been severely damaged and have lost their original luster and color tone, polish the surface lightly with a fine polishing compound. Avoid limiting your polishing to the damaged surface only; polish a somewhat wider area, moving the polishing cloth in one direction. After polishing, flush the compound from the surface and apply a coat of wax to regain a beautiful luster.

To prevent corrosion, touch up small cracks and scratches in the paint coat as soon as possible with touch-up film or paint. Carefully check the body areas facing the road and the tires for damage to the paint coat caused by flying stones, etc.

Plastic Parts

CAUTION (See page 102)

Use a sponge or chamois to clean plastic parts. Use warm water and a soft cloth or chamois to remove any white residue from dark colored plastic surfaces. Do not use a scrubbing brush, other hard tools, or wax containing abrasives as they may damage the plastic surface.

Chrome Parts

To prevent chrome parts from spotting or corroding, wash with water, dry thoroughly, and apply a non-abrasive automotive wax. If the chrome is severely damaged or pitted, use a commercially available chrome polish product.

Vinyl Decals

To help your vinyl decals maintain their image quality, regularly coat them with a UV protective spray. Never apply wax to decals. If using a wash-n-wax product on the RV, apply the UV protective spray (per manufacturer's instructions) prior to washing the RV.

Underbody and Cold Weather

Salt and other chemicals that are spread on winter roads in some geographical areas can have a detrimental effect on the RV's underbody.

If your RV is exposed to these conditions, spray the underbody with a high-pressure hose every time you wash the exterior of your RV.

Take special care to remove mud or other debris that could trap and hold salt or moisture. After washing your RV, wipe off all water drops from the rubber parts around the slideout and doors.

NOTE

When the slideout or door is frozen, opening it by force may tear off or crack the rubber gasket that is installed around the slideout or door. Pour warm water on the gasket to melt the ice (wipe off the water thoroughly after opening the slideout or door). To prevent the weather stripping from freezing, treat it with a silicone spray.

Periodically inspect the exterior exposed areas, and repaint the frame members occasionally whenever you notice rust or paint chipped away, to insure protection.

CLEANING SLIDE-OUT SEALS

While most household cleaners work well for RV slide-out seals, some chemicals may cause degradation of the seal. 409®, Lysol® and similar cleaning products work well.



Following is a list of chemicals that should be avoided due to potential adverse effects on seal performance. Some caulks and sealants may include chemicals listed in the chart below that will degrade performance strength.

Please review material ingredients before using any aftermarket sealant or caulk.

DO NOT USE

- | | |
|--------------------------|---------------------|
| • aliphatic hydrocarbons | • cyclohexanone |
| • amyl acetate | • ethers |
| • amyl alcohol | • gasoline (any) |
| • amyl chloride | • kerosene |
| • aromatic hydrocarbons | • lacquer solvent |
| • benzaldehyde | • linseed oil |
| • benzene | • methane |
| • benzoic acid | • naphtha |
| • benzyl alcohol | • natural gas |
| • butane | • nitrobenzene |
| • butyl acetate | • phenol |
| • carbon disulfide | • styrene |
| • chlorobenzene | • toluene |
| • chlorobromomethane | • trichloroethylene |
| • chloroform | • turpentine |
| • cresol | • vinyl plastisols |
| • cyclohexane | • xylene |

TEST BEFORE USING

- | | |
|---------------------------|-----------------------|
| • acetic anhydride | • acetic anhydride |
| • alcohols | • glycerin |
| • aniline | • iodine & solutions |
| • aniline hydrochloride | • monoethanolamine |
| • butyl alcohol (Butanol) | • oils, animal |
| • carbon tetrachloride | • oils, mineral |
| • ethylene glycol | • oils, vegetable |
| • ethyl alcohol (Ethanol) | • perchloroethylene |
| • fatty acids | • polyglycol |
| • freon | • steam (up to 40psi) |

EXTERIOR

E-Z LUBE® OR SUPER LUBE™ AXLE (IF EQUIPPED)

The E-Z Lube or Super-Lube feature on your axles provides the ability for the bearings to be periodically lubricated without removing the hubs from the axle. When grease is pumped into the grease fitting, it is channeled to the inner bearing and then flows back to the outer bearing and eventually back out the grease cap hole. Be sure to spin the wheel as you fill to allow for even distribution of grease to the bearing.

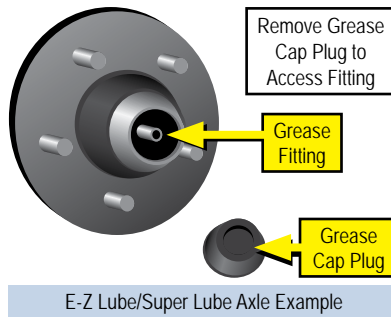

Contact your dealer for additional assistance.

NOTE

The convenient lubrication provisions of the E-Z Lube or Super Lube feature must not replace periodic inspection and maintenance of the bearings. Use a hand-operated grease gun; improper use of a commercial grease gun may damage the seals.

EXTERIOR ROOF AND SIDEWALL VENTS

Inspect the roof vents, including sealants for cracks and keep them clean. Inspect the refrigerator and holding tank vents for blockages from bird nests, spider webs, leaves, etc. All exterior access doors and vents need to be kept clean and free of obstructions (i.e., insect nests, mud daubers, etc.) while the appliances are in use.

WINDOWS

Any ventilating window may permit water inside, especially during heavy rainstorms. Condensation will also cause water to accumulate on windows and in the tracks.

Window glass

The window glass can normally be cleaned with a sponge and water. Use glass cleaner to remove wax, oil, grease, dead insects, etc. After washing the glass, wipe it dry with a clean, soft cloth.

EXTERIOR LADDER (IF EQUIPPED)

⚠ WARNING ⚠ (See page 102)

Your RV may be equipped with an exterior roof ladder. The RV roof has decking under the rubber roof membrane to allow you to walk on the roof (with caution) to do maintenance.

Self-Storing Ladder (If Equipped)



Some models may be equipped with a self-storing ladder mounted to the side of the RV. **Max capacity for this type of ladder is 250 lb.** Ladder should be in the storage position while traveling.

Self-storing ladder operation

1. Pull all the locking pins out of the ladder brackets (A).
2. Pull the ladder down and toward you and it will swing away from the RV.
3. When the brackets are extended (B), re-insert the pins to lock the ladder in place while in use.
4. To return the ladder to the storage position; pull the locking pins and push the ladder up and in towards the RV.
5. When the ladder is in the storage position, re-insert all locking pins to prevent the ladder from opening while traveling.

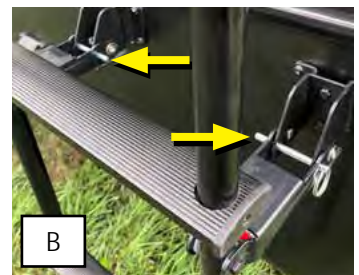

EXTERIOR

On-The-Go Ladder (If Equipped)

Select models may be equipped with an On-The-Go collapsible ladder mounted on the rear of the RV with it's receiver mounted on the side of the RV. **Max capacity for this type of ladder is 330 lb.**

On-The-Go ladder operation

1. Disconnect the lock pins at the base and top of the ladder (C).
2. Raise the lock clasps (D) as the base and top of the ladder.
3. With 2 hands lift the ladder out of the mount.
4. Place the ladder on firm level ground under the ladder receiver. Make sure the ground is free from obstacles, and the ladder rungs and your shoes are clean of debris or any slippery materials.
5. Release the Velcro ladder run retaining strap (E).
6. Raise each section of the ladder until it clicks into place.
7. Place the ladder at a 75 degree angle. The distance from the base to the RV should be about 1/4 the distance to the top of the RV.
8. Place the ladder mounting hooks firmly into the ladder receiver (F) on the side of the RV.

The ladder is now ready for use. For added safety have a second person hold the ladder during ascent and descent.

To store the ladder, reverse the procedure above. To collapse the ladder back to it's original size, press the release buttons (G) on each side of each level simultaneously towards each other to lower each level.

Be careful not to have your fingers or other appendages between the rungs when the level is collapsing.



SEALANTS

⚠ CAUTION ⚠ (See page 102)

Sealants perform a very important function and should be inspected closely and regularly maintained. Many different types of sealants are used, including butyl/putty, black butyl-encapsulated foam, silicone (clear and colored), roof sealant and foam. In general, sealants do not have "set" lifetimes. Varying environmental factors affect the pliability and adhesiveness of sealants.

You or your dealer must:

- Inspect all sealants a minimum of every six months. Make sure to check the roof and all four sides of the RV including all moldings, doors, vents and exterior attachments. A quick walk around the RV before leaving may help prevent potential problems during trips and vacations.
- Have the sealant replaced if you notice any cracks, peeling, voids, gaps, breaks, looseness or any sign of physical deterioration. Reseal at least one time each year as preventative maintenance.
- Always use the same type of sealant that was removed. Your dealer service or parts manager can help you obtain the correct sealant(s).

The sealants may become damaged due to road vibration, ultraviolet exposure, air pollution, freezing temperatures, and exposure to other elements. Repair deteriorated sealants immediately to prevent damage. Cap seal all trim and openings at least once after the first year and thereafter as cracks, peeling, lifting and shrinkage occur.

If you notice water inside the RV, immediately have the dealer check for the source of the leak. Failure to correct the leak may result in serious damage to your RV, and this damage may not be warrantable.

If you have questions and/or need assistance with sealing your RV, consult with your RV dealer.

- Trim Edges
- Roof Items
- Slideout
- Windows

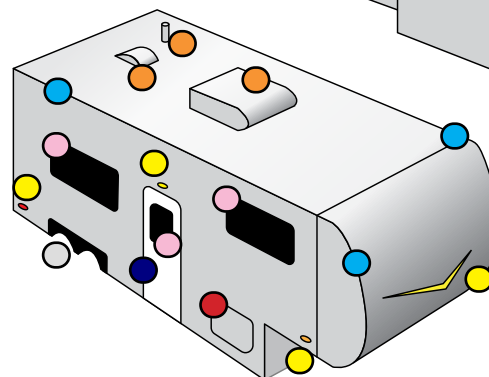
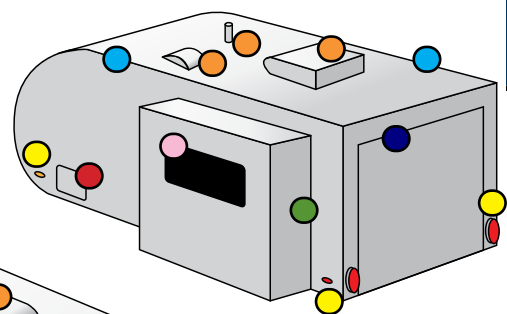

- Doors
- Compartments
- Wheel Wells
- Lights

RV Sealant Diagram



WARNING

EXTERIOR LADDER (page 100)

If your recreation vehicle is equipped with a roof ladder, do not leave items attached to it while traveling. DO NOT exceed the weight rating of the ladder. The ladder weight capacity label is located under the bottom step of the ladder. There should never be more than one person on the ladder at the same time.

Self-Storing ladders: Make sure to pull all pins (there may be up to 4) to unlock the ladder. All pins must be re-inserted when locking the ladder open for use.

LADDER CAPACITY MAXIMUM 300 lbs. (136 kg)

DO NOT exceed the ladder maximum weight rating.

The maximum rating includes the person's weight PLUS weight of items carried.

When climbing:

- Always face the ladder.
- Climb slowly with weight centered between side rails.
- Keep a 3 point contact on the ladder at all times (3 point contact-two hands and a foot or two feet and one hand).

Keep hands free.

- Use of accessories such as lanyards to keep carried items tethered will keep hands free and prevent falling items.
- Heavy or bulky items should be brought up only after reaching the roof.

Do not use the ladder if damaged in any way.

Failure to follow these guidelines could result in death or serious injury.

CAUTION

PAINTED SURFACES (page 98)

Do not use waxes containing high-abrasive compounds. Such waxes remove rust and stains effectively from the paint work, but they are also harmful to the luster of the painted surface since they scrape off the coating. Further, they are detrimental to glossy surfaces, such as the grille, garnish, moldings, etc. Do not use gasoline or paint thinners to remove road tar or other contamination to the painted surface.

Do not use a buffer and a buffing compound as it may damage the exterior surface. Please contact a professional paint body shop for assistance.

PLASTIC PARTS (page 99)

Do not allow plastic to come into contact with brake fluid, engine oil, grease, paint thinner, or battery acid. These will damage plastic. Use a soft cloth and a mild detergent solution to wipe away any such contact.

SEALANTS (page 101)

Failure to properly maintain or reseal your recreation vehicle may result in serious water damage to the roof and other parts of the recreation vehicle. This damage is not covered by the Limited Warranty.

To check the exterior sidewall sealants, use a stepladder placed safely alongside the vehicle. Do not prop a ladder against the body of the RV as it may damage the exterior finish.



SECTION 14: CHECKLISTS



TRAVEL CHECKLIST

Following is a preliminary list of items that need to be checked before leaving your home or campsite. This is a general list, which you may want to customize as you determine your own needs.

For your convenience a quickstart guide is also available from within the JAYCOMMAND/TravelLINK mobile phone app (if equipped) that walks you through the steps to setup your RV at the campsite or prepare it for travel.

Safety

- ❑ **Make sure you follow all safety precautions noted in this owner's manual and in any manufacturer's operators manual when preparing to travel.**

Maintenance

- ❑ Inspect seals and reseal as needed.
- ❑ Have the propane system checked for leaks by your dealer.
- ❑ Check wheel lug nuts after first two hundred miles and at specified intervals to listed torque specifications, re-torque as needed.
- ❑ Have brakes adjusted by a qualified service technician.
- ❑ Sanitize the fresh water system.
- ❑ Test the safety alarms.

Before leaving home (or campsite)

- ❑ Make sure all tow vehicle fluids are at proper levels. Check the engine oil, transmission fluid, engine coolant, power steering fluid and wind shield washer fluid.
- ❑ **Check the lights on the RV. Have someone observe the operation of all exterior lights while you activate the controls. Check the turn signals and brake lights.**
- ❑ Examine the tires for excessive tread wear or uneven wear patterns. Check for stones, nails, glass or other objects lodged in the tread. Inspect for tread cuts or sidewall cracks.
- ❑ **Check tire pressure** (including spare) and correct according to manufacturer specifications.

- ❑ **Check wheel lug nuts for tightness.**
- ❑ **Inspect safety chains for signs of wear.**
- ❑ Inspect and work all interior and exterior latches and locks (lube if necessary).
- ❑ Make sure the batteries are fully charged and installed correctly.
- ❑ Inspect the power cord and carefully clean the contacts if necessary. Plug in the power cord to an appropriate power source.
- ❑ Turn on the interior lights and check outlets for polarity. If needed, replace any blown fuses. Check the circuit breakers and test the GFCI.
- ❑ Check the propane cylinder gauge to make sure there is propane available. Make sure the propane cylinder is in place and secure for transport.
- ❑ **Inspect and turn on the propane system.** If you have any questions, contact your dealer or a qualified propane service representative for assistance. If the propane system is functioning properly, test any pilot lights or direct spark ignition features. Turn off the propane when finished.
- ❑ **Inspect and test all safety detectors.** If needed, replace any drained or discharged batteries. If you have a defective or damaged safety detector, replace it immediately.
- ❑ Inspect the leveling jacks (if equipped) for operation. If needed, perform maintenance as specified by the leveling jack manufacturer.
- ❑ Test all exterior and interior lights. Replace any bulbs if they are burnt out.
- ❑ Wash the exterior of the RV. Do a sealant inspection and repair as necessary.
- ❑ De-winterize and **sanitize** the fresh water system.
- ❑ **Connect your tow vehicle to the RV and test all connections and lights.**
- ❑ **Test brakes.**

CHECKLISTS

Before leaving the campsite

- Check the area under the RV after overnight parking and look for water or other fluid leaks. If leaks are detected, find the cause and correct it immediately.
- Turn off propane tanks.
- Empty black and gray holding tanks, rinse as needed (if equipped). Store sewer hose.
- Retract awning and secure in place for transport (if equipped).
- Close roof vents.
- Close windows & latch blinds.
- Disconnect any cable TV or phone hookup, and lower the TV antenna (if equipped).
- Turn off interior lights.
- Turn off water heater, water pump, furnace and appliances.
- Snap the Range Hood vent closed (if equipped).
- Latch drawers, cabinets & doors. Counter items put away or tied down.
- Fasten and secure the furniture for travel (if equipped).
- Refrigerator door locked (if equipped). Set to 12-volt (if applicable).
- Secure any loose, heavy or sharp objects in the RV or exterior compartments.
- Disconnect the power cord and ensure it is stored correctly.
- Disconnect any water connections, and store water hose.
- Store any personal items from around the RV (lawn chairs, tables, etc.).
- Fasten all interior and exterior doors securely. Lock them (if equipped).
- Move slideout(s) in and lock it in place (if equipped).
- Walk around your RV to make sure everything is stored away and the baggage compartments are closed and locked.
- Retract leveling jacks to the travel position (if equipped).
- Retract step.
- Secure and lock the entrance door.
- Inspect the camp site and clean up any trash or debris.
- Don't forget the dog and kids (if equipped).

RV STORAGE CHECKLIST

Properly preparing your RV for storage during periods of non-usage will prevent problems from arising. It will also make it easier to get started again for the following camping trip or season. To prevent costly freeze-ups, winterize the plumbing system when it will not be in use for an extended period of time, especially if it is stored in colder climates.

Prior to Storage

- Store your RV indoors, under a roof or a "breathable" cover for use during storage.

- To prevent weather checking and other UV damage, cover tires exposed to sunlight.
- Thoroughly wash the interior and the exterior of your RV.
- Lubricate stabilizing jacks with WD40 or white lithium grease then raise for storage.
- Check the roof and other surfaces to ensure there is no damage and potential leakage that might otherwise go unnoticed.
- Inspect and seal off any area that offers an entry point for rodents, birds or insects. Cover all external outlets (i.e. furnace, vents etc.). Damage from birds, rodents, insect, etc., is not covered under the "Towable Limited Warranty".
- Close all windows and roof vents.
- Cover the roof air conditioner (if equipped).
- Close the propane cylinder valve(s). We recommend using a propane cylinder cover, and to make sure the propane regulator is covered. If equipped with a gas/electric DSI range, light a range gas burner to consume any gas remaining in the lines. Once the flame extinguishes itself, turn the burner valve OFF.
- Drain all water lines. Make sure the RV is winterized
- Drain and flush all holding tanks (fresh water, gray water, black water and/or hot water tanks).
- Adding fuel stabilizer to the generator (if equipped) will aid in preventing condensation and fuel varnishing.
- Disconnect 120-volt AC power to the RV.
- Remove all batteries from the RV and store in a place where they will not freeze. A battery that has been frozen will never hold a proper charge.
- Turn all cushions on edge to prevent the moisture/mildew buildup during storage.
- Turn off 12-volt DC/120-volt AC/propane to the refrigerator; defrost and clean. Block the doors open so air can circulate and prevent mildew, or use crumpled newspaper or open boxes of baking soda in the refrigerator to eliminate odors during storage.
- Remove all perishables from the cabinets. Leave the cabinets and doors ajar to allow air circulation and prevent mildew and musty odors.
- Lubricate locks and hinges on exterior doors.

During Storage Period

Remove snow from the top of your RV to prevent damage to the unit's structure.

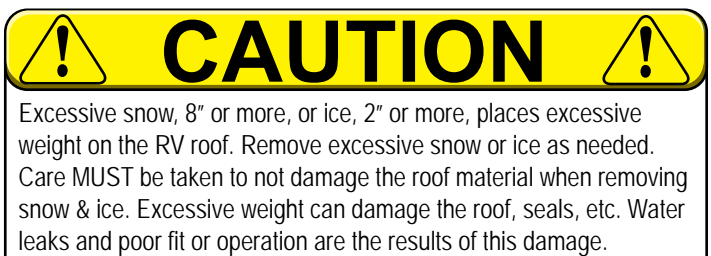

SECTION 15: ADDITIONAL INFORMATION



FEATURED COMPONENTS QUICK REFERENCE CHART

Your RV may be equipped with some of the items listed below. This is a partial listing and it is not intended to cover all components. All information is the latest available at the time of publication. Jayco reserves the right to change any of the following information without notice.

COMPONENT	MANUFACTURER	WEBSITE
Air Conditioner	Dometic Furrion GE Coleman-Mack	Dometic.com Furrion.com GEAppliances.com AirXCEL.com
Awning	LCI - Lippert Dometic Carefree	rvtechbridge.lippert.com Dometic.com CarefreeColorado.com
Axle	Dexter Axle LCI - Lippert	DexterAxle.com rvtechbridge.lippert.com
Entrance Step	Elkhart Tool & Die LCI - Lippert Mor/Ryde	postledistributors.com rvtechbridge.lippert.com MorRyde.com
Fan	MaxxAir Ventline	MaxxAir.com DexterAxle.com
Furnace	Dometic Suburban	Dometic.com SuburbanRV.com
Monitor Panel	KiB Positron ATC BMPro	www.ATComp.com PositronCorp.com www.ATComp.com TeamBMPro.com
Propane Regulator	Fairview USA Marshall Excelsior Cavagna Group	FairviewFittings.com MarshallExcelsior.com CavagnaGroup.com
Range/ Stove/ Cooktop	Insignia DDR Furrion Greystone Suburban	www.InsigniaProducts.com Call: 574-622-0402 Furrion.com Furrion.com SuburbanRV.com

COMPONENT	MANUFACTURER	WEBSITE
Range Hood	Furrion Ventline Heng's	Furrion.com DexterAxle.com HengIndustries.com
Refrigerator	Dellcool Dometic Furrion Norcold RVision Everchill Whirlpool LG GE	Dellcool.com Dometic.com Furrion.com Norcold.com RVisionIntl.com Furrion.com Whirlpool.com LG.com GEAppliances.com
Thermostat	Dometic Furrion Suburban Coleman-Mack Truma	Dometic.com Furrion.com SuburbanRV.com AirXCEL.com Truma.net
TV Antenna	Winegard	Winegard.com
Water Heater	Dometic Suburban	Dometic.com SuburbanRV.com
Water Heater Tankless	Furrion Suburban Truma	Furrion.com SuburbanRV.com Truma.net
Water Pump	Seaflor Shurflo	SeaflorUSA.com Pentair.com

For information on other items including DVD/CD Player, Fire Extinguisher, Microwave, Propane/Carbon Monoxide Alarm, Smoke Alarm, TV, etc., see the manufacturer's user guide. Contact Customer Service for additional help.

ADDITIONAL INFORMATION

HELPFUL LINKS

Disclaimer: These links are being provided as a convenience and for informational purposes only; they do not constitute an endorsement by Jayco Inc. or any of its subsidiaries regarding any of the products, services, or opinions contained within. Jayco Inc. bears no responsibility for the accuracy, legality or content of the external site or for that of subsequent links. Contact the external site for answers to questions regarding its content.

NEWS & STORIES

Go RVing
gorving.com



The Go RVing program is the consumer-facing voice of the RV industry with a mission to inspire potential RVers, spark curiosity, and raise awareness about the benefits and accessibility of RVing through rich, authentic, and diverse storytelling.

TRAVEL RESOURCES

Bring Fido
bringfido.com



Explore over 500,000 places to stay, play, and eat with your dog.

U.S. Dept. of Transportation
fhwa.dot.gov/trafficinfo/index.htm



Federal Highway Administration's National Traffic and Road Closure Information

National Weather Service
weather.gov/alerts



National Weather Service Weather Alerts

Roadtrippers
roadtrippers.com



Plan your next road trip route with Roadtrippers. Enter where you want to start and finish your road trip, and then discover the coolest "off the beaten path" places along the way.

Included in "Roadpass Pro".

Sanidumps
sanidumps.com



Sanidumps is a comprehensive RV dump station search site.

Togo RV
togorv.com



Features and benefits include RV-specific GPS navigation, high-value member discounts, access to free boondocking locations, service and maintenance schedule tracking, customizable checklists, RV Living stories, and a mobile repair locator.

Included in "Roadpass Pro".



CLUBS & ORGANIZATIONS

FMCA
fmca.com



Your RVing Family

The FMCA educates, equips, and empowers RV owners in their journey to creating, experiencing, and benefiting from the outdoor lifestyle they dream of and deserve. All motorized and towable RVs welcome.

Good Sam Club
goodsam.com



Part of the RV community since 1966, Good Sam was founded on the idea of being good, doing good, and helping others. With over 2 million Good Sam Members and over 2100 Good Sam Parks and campgrounds, Good Sam makes it easy to travel and connect. Good Sam also offers a full suite of protection products including insurance, roadside assistance, extended service plans, and more.

Harvest Hosts
harvesthosts.com



Harvest Hosts is an RV membership program that provides unlimited overnight stays at thousands of locations nationwide such as farms, breweries, wineries, and much more. New members save 20% off of their first year of membership with the code JAYCO20.

Passport America
passportamerica.com



Passport America is a discount membership club that provides half price camping to a network of Over 1,200+ quality campgrounds and RV parks throughout the U.S., Canada and Mexico.

CAMPSITE LOCATORS

Go Camping America
gocampingamerica.com

Whether you're planning the cross-country trip of a lifetime or just a weekend getaway, GoCampingAmerica.com is the best way to find the perfect home away from home for your next adventure.



AllStays
allstays.com

AllStays has comprehensive lists, maps, apps, and search tools for over 37,000 campsites.



National Park Service - Find a Park
nps.gov/findapark

The National Park Service website is a great resource for information on the national parks across the country. From there you can find a park, research events, and discover trip ideas.



Campendium
campendium.com

Campendium lists tens of thousands of places to camp, vetted by their team, and reviewed by over 750,000+ members.

Included in "Roadpass Pro".



RV Life Campground Reviews
campgrounds.rvlife.com

RV Life Campground Reviews will help you find a campground with easy to use maps and visitor reviews.



USCampgrounds.info
uscampgrounds.info

Web listing of over 13,000 public campgrounds in the US and Canada that are vehicle-accessible, family campgrounds with 4 or more campsites.



OTHER INFORMATION

Neighbor
neighbor.com/rv-storage-near-me



Get out and use your RV more, store it with a neighbor. Find a spot on Neighbor.com—the world's largest RV storage & self-storage marketplace. Find space in your neighborhood today, it's closer, safer, and cheaper than traditional RV storage. Neighbor.com, like it never left home.

RVIA
rvia.org



RV Industry Association is the leading trade voice of the RV industry, representing approximately 495 manufacturers and component and aftermarket suppliers who together produce 98 percent of all RVs made in the United States, and approximately 60 percent of RVs produced worldwide.

Roadpass Pro
roadpass.com/pro



Purchasing a new Jayco Family RV makes you eligible for one FREE year of Roadpass Pro, which includes bonus features to the apps "Campendium", "Roadtrippers", and "Togo RV".

Visit roadpass.com/first to sign up.

Current owners can receive a 30% discount on Roadpass Pro using the discount code below for your RV.

- Entegra Coach: ENTEGRA30
- Highland Ridge RV: HIGHLANDRIDGE30
- Jayco RV: JAYCO30
- Starcraft RV: STARCRAFT30





JAYCO | 903 S. Main Street, Middlebury, IN 46540 | (800) 283-8267

For more information on model features and options, documentation, and the electronic version of this owner's manual, please visit the manufacturer's website or scan the QR code found on the decal just outside the front door of the recreational vehicle.